



**2004
WaveRunner
XL700**

**OWNER'S/OPERATOR'S
MANUAL**

**READ THIS MANUAL
CAREFULLY BEFORE OPERATION!**

YAMAHA MOTOR CO., LTD.
F0M-F8199-75

EC declaration of conformity

E

THE MANUFACTURER:

Yamaha Motor Europe N.V.

P.O.Box 75033; 1117 ZN Schiphol; The Netherlands

HEREBY DECLARES THAT THE

**Yamaha Personal Watercraft,
type and serial number :
XL700 (F0M824381-)**

COMPLIES WITH THE PROVISIONS OF THE

Directive 89/336/EEC relating to electromagnetic compatibility (EMC),

COMPLIES WITH THE PROVISIONS OF THE FOLLOWING
HARMONIZED STANDARD:

- EN 50082-2

ALSO COMPLIES WITH THE FOLLOWING EUROPEAN STANDARDS,
NATIONAL STANDARDS AND TECHNICAL PROVISIONS:

- CISPR 12.

Done at Schiphol, (The Netherlands),

On, 2003-05-13



M. Inumaru,

President

Yamaha Motor Europe N.V.

To the owner/operator

Thank you for choosing a Yamaha watercraft.

This Owner's/Operator's Manual contains information you will need for proper operation, maintenance, and care. A thorough understanding of these simple instructions will help you to obtain maximum enjoyment from your new Yamaha. If you have any questions about the operation or maintenance of your watercraft, please consult a Yamaha dealer.

Because Yamaha has a policy of continuing product improvement, this product may not be exactly as described in this Owner's/Operator's Manual. Specifications are subject to change without notice.

This manual should be considered a permanent part of this watercraft and should remain with it even if the watercraft is subsequently sold.

EJU01204

Important manual information:

In this manual, information of particular importance is distinguished in the following ways:



The Safety Alert Symbol means **ATTENTION! BECOME ALERT! YOUR SAFETY IS INVOLVED!**

!WARNING

Failure to follow WARNING instructions could result in severe injury or death to the machine operator, passengers, a bystander, or a person inspecting or repairing the watercraft.

CAUTION:

A CAUTION indicates special precautions that must be taken to avoid damage to the watercraft.

NOTE:

A NOTE provides key information to make procedures easier or clearer.

EJU00991

**WaveRunner XL700
OWNER'S/OPERATOR'S MANUAL
©2003 by Yamaha Motor Co., Ltd.
1st Edition, May 2003
All rights reserved.
Any reprinting or unauthorized use
without the written permission of
Yamaha Motor Co., Ltd.
is expressly prohibited.
Printed in USA**

CONTENTS



GENERAL AND SAFETY INFORMATION

1

FEATURES AND FUNCTIONS

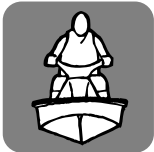
2

OPERATION

3

MAINTENANCE AND CARE

4

TROUBLESHOOTING AND EMERGENCY PROCEDURES

5

APPENDIX

6

**READ THIS OWNER'S/OPERATOR'S MANUAL CAREFULLY
BEFORE OPERATING YOUR WATERCRAFT.**

EJU00993

GENERAL AND SAFETY INFORMATION



Identification numbers	1-1
Primary Identification (PRI-ID) number	1-1
Hull Identification Number (HIN)	1-1
Engine serial number	1-1
Emission control information (For Canada only)	1-2
Approval label of Emission control certificate	1-2
Manufactured date label	1-2
Important labels	1-3
Label location	1-3
Warning labels	1-4
Other labels	1-7
Safety information	1-9
Limitations on who may operate the watercraft	1-9
Cruising limitations	1-10
Operation requirements	1-11
Recommended equipment	1-13
Hazard information	1-14
Watercraft characteristics	1-14
Water-skiing	1-15
Safe boating rules	1-17
Enjoy your watercraft responsibly	1-17

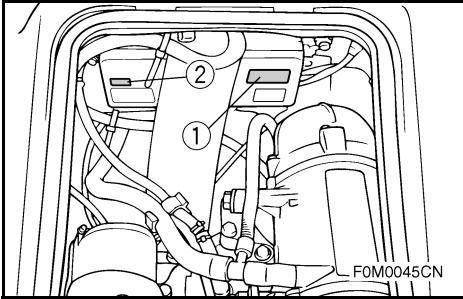

EJU19870

Emission control information (For Canada only)

This engine conforms to 2004 U.S. Environmental Protection Agency (EPA) regulations for marine SI engines.

EJU12060

Approval label of Emission control certificate

This label is attached to the electrical box.

① Emission control information label

EMISSION CONTROL INFORMATION	
ENGINE FAMILY: []	
THIS ENGINE CONFORMS TO 2004 U.S. EPA REGULATIONS FOR MARINE SI ENGINES.	
FELs: [] g/kw-hr	SPARK PLUG GAP (mm): []
	TROLLING SPEED: [] rpm
INFORMATION ANTIPOLLUTION	
CATEGORIE DU MOTEUR: []	
CE MOTEUR EST CONFORME AUX NORMES U.S. 2004 EPA POUR MOTEURS NAUTIQUES SI.	
FELs: [] g/kw-hr	BOUGIE-ECARTEMENT (mm): []
	REGIME EMBRAYE: [] tr/min
YAMAHA MOTOR CO.,LTD. []	

EJU19880

Manufactured date label

This label is attached to the electrical box.

② Manufactured date label

YAMAHA
Manufactured: [][][][][][]



EJU00998

Important labels

EJU01351

Label location

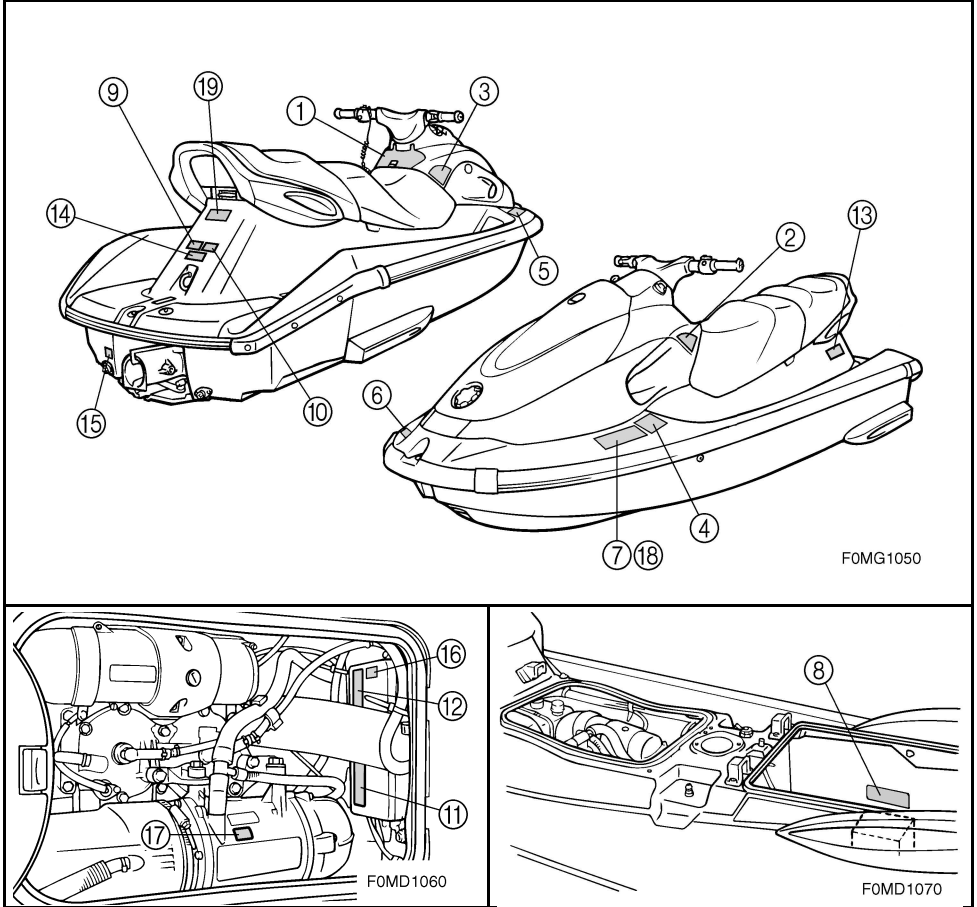

EJU19890

Warning labels

①

⚠ WARNING

To reduce the risk of SEVERE INJURY or DEATH:

WEAR A PERSONAL FLOTATION DEVICE (PFD). All riders must wear an authority-approved PFD that is suitable for personal watercraft (PWC) use.

WEAR PROTECTIVE CLOTHING. Severe internal injuries can occur if water is forced into body cavities as a result of falling into water or being near jet thrust nozzle. Normal swimwear does not adequately protect against forceful water entry into rectum or vagina. All riders must wear a wet suit bottom or clothing that provides equivalent protection (See Owner's Manual).

Footwear, gloves, and goggles/glasses are recommended.

KNOW BOATING LAWS. Yamaha Motor Co., Ltd. recommends a minimum operator age of 16 years old. Know the operator age and training requirements for your state. A boating safety course is recommended and may be required in your state.

ATTACH ENGINE SHUT-OFF CORD (LANYARD) to wrist and keep it free from handlebars so that engine stops if operator falls off.
After riding, remove cord



PFD

Wet Suit Bottom

from PWC to avoid unauthorized use by children or others.

RIDE WITHIN YOUR LIMITS AND AVOID AGGRESSIVE MANEUVERS to reduce the risk of loss of control, ejection, and collision. This is a high performance boat – not a toy. Sharp turns or jumping wakes or waves can increase the risk of back/spinal injury (paralysis), facial injuries, and broken legs, ankles, and other bones. **Do not jump wakes or waves.**

DO NOT APPLY THROTTLE WHEN ANYONE IS AT REAR OF PWC – turn engine off or keep engine at idle. Water and/or debris exiting jet thrust nozzle can cause severe injury.

KEEP AWAY FROM INTAKE GRATE while engine is on. Items such as long hair, loose clothing, or PFD straps can become entangled in moving parts resulting in severe injury or drowning.

NEVER RIDE AFTER CONSUMING DRUGS OR ALCOHOL

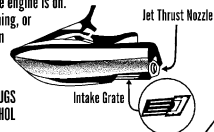

Intake Grate

Jet Thrust Nozzle

READ AND FOLLOW OWNER'S MANUAL

FOM-U41B1-12

YAMAHA

②

⚠ AVERTISSEMENT

Afin de limiter les risques de **BLESSURES GRAVES, voire MORTELLES: PORTER UN GILET DE SAUVETAGE.**

Tout utilisateur doit porter un gilet de sauvetage homologué pour les scooters des mers.

PORTER DES VÊTEMENTS PROTECTEURS.

Le choc infligé par la pénétration forcée d'eau dans les orifices corporels lors d'une chute ou lors du contact avec le jet d'eau de la pompe risque de provoquer des lésions graves. Le port d'un simple maillot de bain ne constitue pas une protection adéquate contre la puissance de pénétration de l'eau dans le rectum et/ou le vagin.

Tout utilisateur doit porter le pantalon d'une tenue de plongée ou tout autre vêtement offrant une protection semblable. (Voir le manuel d'utilisation.) Le port de chaussures, de gants et de lunettes de plongée est recommandé.

CONNAÎTRE LES LOIS DE NAVIGATION.

Le Yamaha Motor Co., Ltd. recommande la limite d'âge de pilotage de 16 ans. Vérifier l'âge du pilote ainsi que les exigences quant à l'âge prévues par la législation locale. Il est préférable, et parfois requis par certaines législations, de suivre un cours de sécurité maritime.

ATTACHER LA LANIÈRE DE L'INTERRUPTEUR D'ARRÊT DU MOTEUR au poignet et

l'attacher au guidon afin que le moteur se coupe bien en cas de chute. Après utilisation, retirer la lanière du scooter afin de prévenir toute utilisation par des enfants ou des personnes non-autorisées.



Gilet de sauvetage

Tenue de plongée

YAMAHA

③

⚠ AVERTISSEMENT

Afin de limiter les risques de **BLESSURES GRAVES, voire MORTELLES:**

RESPECTER SES LIMITES ET ÉVITER LES

MANŒUVRES BRUTALES afin de limiter tout risque de perte de contrôle, d'éjection et de collision. Il s'agit d'un véhicule à hautes performances et pas d'un jouet. Des virées brusques ou le saut de sillages ou de vagues accroît le risque de blessures au dos, voire de paralysie, de blessures au visage et de fractures diverses. **Ne jamais sauter des sillages ni des vagues.**

NE PAS DONNER DES GAZ LORSQUE QUELQUIN SE TROUVE DERRIÈRE LE VÉHICULE: couper le moteur ou laisser tourner au ralenti. Eau et/ou débris projetés par la pompe pourraient causer des blessures graves.

NE PAS S'APPROCHER DE LA GRILLE D'ADMISSION lorsque le moteur tourne. Cheveux longs, vêtements amples ou lanières de gilet de sauvetage risquent d'être happés, ce qui pourrait provoquer des blessures, ou même une noyade.

NE JAMAIS PILOTER APRÈS AVOIR ABSORBÉ DE L'ALCOOL, DES DROGUES OU CERTAINS MÉDICAMENTS.



Grille d'admission

Pompe

LIRE ET RESPECTER LES INSTRUCTIONS DONNÉES DANS LE MANUEL D'UTILISATION.

YAMAHA



④

⚠ WARNING

Collisions result in more **INJURIES AND DEATHS** than any other type of accident for personal watercraft (PWC).

TO AVOID COLLISIONS:

SCAN CONSTANTLY for people, objects, and other watercraft. Be alert for conditions that limit your visibility or block your vision of others.



OPERATE DEFENSIVELY at safe speeds and keep a safe distance away from people, objects, and other watercraft.

- Do not follow directly behind PWCs or other boats.
- Do not go near others to spray or splash them with water.
- Avoid sharp turns or other maneuvers that make it hard for others to avoid you or understand where you are going.
- Avoid areas with submerged objects or shallow water.

TAKE EARLY ACTION to avoid collisions. Remember, PWCs and other boats **do not have brakes**.

DO NOT RELEASE THROTTLE WHEN TRYING TO STEER away from objects - **you need throttle to steer**. Always check throttle and steering controls for proper operation before starting PWC.

Follow navigation rules and state/province and local laws that apply to PWCs. See Owner's Manual for more information.

YAMAHA

FOM-U41B2-00

⑤

⚠ AVERTISSEMENT

Les collisions sont la cause principale des **BLESSURES ET DÉCÈS** d'utilisateurs de scooter des mers.

POUR ÉVITER LES COLLISIONS:

ÊTRE CONSTAMMENT à l'affût de personnes, d'objets et d'autres bateaux. Être conscient des conditions limitant sa visibilité ou celle des autres embarcations.



PILOTER AVEC PRUDENCE à des vitesses raisonnables et garder une distance de sécurité entre le scooter et toute personne, objet et embarcation.

- Ne pas suivre une autre embarcation de trop près.
- Ne pas se rapprocher d'autrui en vue de l'éclabousser.
- Éviter les virages brusques ou toute manœuvre qui risque de mettre un autre pilote en danger ou qui l'empêche de pouvoir déterminer clairement la direction que l'on prend.
- Éviter les endroits où flottent des objets et les eaux peu profondes.

RÉAGIR RAPIDEMENT en vue d'éviter les collisions. Garder à l'esprit que les bateaux n'ont pas de freins.

NE PAS LÂCHER LES GAZ LORSQUE L'ON ESSAYE DE S'ÉLOIGNER d'objets - une poussée est nécessaire à la direction du scooter des mers.

Toujours s'assurer avant le départ que l'accélérateur et la direction fonctionnent correctement.

Suivre les lois de navigation ainsi que les législations nationales, provinciales et locales concernant les scooters des mers. Voir le manuel d'utilisation pour plus d'informations.

YAMAHA

FOM-U41B2-10

⑥

⚠ WARNING

Gasoline is highly flammable and explosive. A fire or explosion could cause severe injury or death. Shut engine off. Refuel in well ventilated area away from flames or sparks. Do not smoke. Avoid spilling gasoline. Wipe up spilled gasoline immediately.

Remove oil seats and front storage compartment to ventilate fuel vapors from engine compartment before starting engine. Do not start engine if there is a fuel leak or a loose electrical connection.

REGULAR UNLEADED GASOLINE ONLY**⚠ AVERTISSEMENT**

L'essence est très inflammable et explosive. Un incendie ou une explosion risquent de provoquer des blessures graves, voire mortelles. Couper le moteur. Faire le plein dans un endroit bien aéré et éloigné de toute flamme ou étincelle. Ne pas fumer. Éviter de renverser de l'essence. Essuyer immédiatement toute coulure d'essence. Déposer les selles et le compartiment de rangement avant pour évacuer les vapeurs d'essence du compartiment du moteur avant de mettre le moteur en marche. Ne jamais mettre le moteur en marche en cas de fuite d'essence ou si un branchement électrique est desserré.

ESSENCE NORMALE SANS PLOMB UNIQUEMENT

FOV-U415B-00

⑦ (For Europe only)

⚠ AVERTISSEMENT

APPLICABLE POUR LA FRANCE SEULEMENT

- En France : permis de conduire et immatriculation obligatoire.
- Navigation en mer autorisée entre 300 mètres et 1 mille nautique.
- Entre 0 et 300 mètres, se référer aux instructions nautiques locales affichées.
- Sinon, règle générale : **vitesse maxi 5 noeuds (9Km/h)** dans cette zone.
- Utiliser les chemaux obligatoires de sortie lorsqu'ils existent.
- Respecter les règles de priorité.
- Gilet de sauvetage obligatoire-Fusée et bout de remorquage à bord.
- Ne jamais conduire sous l'influence de l'alcool ou de drogues.
- Consulter la météo avant de sortir en mer.
- Une conduite responsable et un contrôle quotidien de votre machine suivant le manuel d'entretien YAMAHA seront garants de votre sécurité.

YAMAHA

GJ3-U415B-00

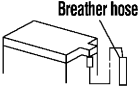
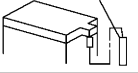

8

⚠ WARNING	
<p>Be sure to connect breather hose to battery. Fire or explosion could result if not connected properly.</p>	 <p>Breather hose</p>
⚠ AVERTISSEMENT	
<p>Bien veiller à brancher la durit de mise à l'air à la batterie. Un mauvais branchement risque d'être à l'origine d'un incendie ou d'une explosion.</p>	 <p>Mise à l'air</p>
<p>YAMAHA</p>	

FOV-U41DB-11

9

⚠ WARNING
<p>Do not use cleat or grips to lift PWC. PWC could fall, which could result in severe injury.</p>
⚠ AVERTISSEMENT
<p>Ne pas soulever le scooter à l'aide du taquet ou des poignées. Le scooter pourrait tomber et provoquer des blessures graves.</p>

(FOV-U41E1-40)

10

⚠ WARNING
<ul style="list-style-type: none"> • Severe internal injuries can occur if water is forced into body cavities as a result of being near jet thrust nozzle. • Wear a wetsuit bottom or clothing that provides equivalent protection. • Do not board PWC if operator is applying throttle.
⚠ AVERTISSEMENT
<ul style="list-style-type: none"> • Le choc infligé par la pénétration forcée d'eau dans les orifices corporels lors du contact avec le jet de la pompe risque de provoquer des lésions graves. • Porter le pantalon d'une tenue de plongée ou tout autre vêtement offrant une protection semblable. • Ne pas embarquer lorsque la pilote donne des gaz.

(FOV-U41E1-40)

11

⚠ WARNING
<p>Do not touch or remove electrical parts when starting or running the engine.</p>
<p>YAMAHA</p>

6R7-83623-40

12

⚠ AVERTISSEMENT
<p>Ne pas toucher ou retirer les pièces électriques lors du démarrage ou de la marche du moteur.</p>
<p>YAMAHA</p>

6R7-83623-50



EJU19900

Other labels

⑬

FIRE EXTINGUISHER
<ul style="list-style-type: none"> • Fire extinguisher is under rear seat. • To remove seat, pull rear seat latch up, and then pull seat off.
EXTINCTEUR
<ul style="list-style-type: none"> • L'extincteur se trouve sous la selle arrière. • Pour déposer la selle, relever l'attache arrière de la selle, puis retirer la selle.

YAMAHA

FOM-U41F6-11

⑭

RATED PERSON CAPACITY: 3 MAXIMUM LOAD: 240 kg (530 lb) CAPACITÉ MAXIMALE: 3 personnes CHARGE MAXIMALE: 240 kg(530 lb)
--

(FOV-U41E1-40)

⑮

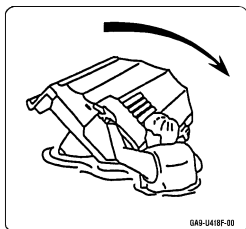

⑯ (For Europe only)

YAMAHA MOTOR CO., LTD. SHIZUOKA JAPAN
YAMAHA
<small>4GB-2155A-00</small>

⑰







18 (For Canada only)

This spark ignition system meets all requirements of the Canadian Interference Causing Equipment Regulations.
Ce système d'allumage par étincelle de véhicule respecte toutes les exigences du Règlement sur le matériel brouilleur du Canada.

YAMAHA

GJ3-U419E-00

19 (For Canada only)

 Fisheries and Oceans Canada Coast Guard		Pêches et Océans Canada Garde côtière		 Canada	
BUILDER - CONSTRUCTEUR			MODEL - MODELE		
YAMAHA MOTOR CANADA LTD. (YAM)			WAVE RUNNER XL700 XL700-C		
THE MANUFACTURER CERTIFIES THAT THIS PRODUCT COMPLIES WITH THE CONSTRUCTION STANDARDS FOR SMALL VESSELS.			LE FABRICANT CERTIFIE QUE CE PRODUIT EST CONFORME AUX NORMES DE CONSTRUCTION DES PETITS BATEAUX.		
<div style="border: 1px solid black; padding: 5px; width: fit-content;">NO. - no</div>					



EJU00999



Safety information

The safe use and operation of this watercraft is dependent upon the use of proper riding techniques, as well as upon the common sense, good judgment, and expertise of the operator. Before using this watercraft, make sure that its use is permitted under local laws, bylaws and regulations and always operate the watercraft in full conformity with any requirements and limitations imposed. Every operator should know the following requirements before riding the watercraft.

- Before operating the watercraft, read this Owner's/Operator's Manual, the Riding Practice Guide, and all warning and caution labels on the watercraft. These materials should give you an understanding of the watercraft and its operation.
- Never allow anyone to operate this watercraft until they too have read this Owner's/Operator's Manual, the Riding Practice Guide and all warning and caution labels.

EJU01207

Limitations on who may operate the watercraft

- Yamaha recommends a minimum operator age of 16 years old. Adults must supervise use by minors. Know your local operator age and training requirements.

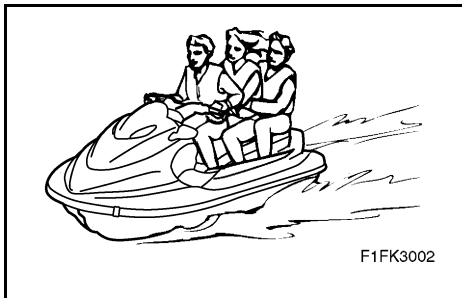

- This watercraft is designed to carry the operator and up to 2 passengers. Never exceed the maximum load limit or allow more than 3 persons (or 2 persons if a water-skier is being pulled) to ride the watercraft at one time.

Maximum load: 240 kg (530 lb)
Load is the total weight of cargo,
operator and passengers.

- Do not operate the watercraft with any passengers on board until you have considerable practice and experience riding alone. Operating the watercraft with passengers requires more skill. Take the time to become accustomed to the handling characteristics of the watercraft before trying any difficult maneuvers.



EJU01001

Cruising limitations

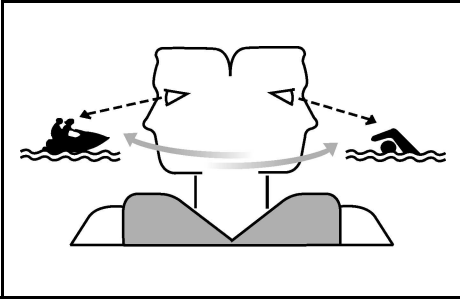

- Scan constantly for people, objects, and other watercraft. Be alert for conditions that limit your visibility or block your vision of others.
- Operate defensively at safe speeds and keep a safe distance away from people, objects, and other watercraft.
- Do not follow directly behind watercraft or other boats.
- Do not go near others to spray or splash them with water.
- Avoid sharp turns or other maneuvers that make it hard for others to avoid you or understand where you are going.
- Avoid areas with submerged objects or shallow water.
- Ride within your limits and avoid aggressive maneuvers to reduce the risk of loss of control, ejection, and collision.
- This is a high performance boat—not a toy. Sharp turns or jumping wakes or waves can increase the risk of back/spinal injury (paralysis), facial injuries, and broken legs, ankles and other bones. Do not jump wakes or waves.

- Do not operate the watercraft in rough water, bad weather or when visibility is poor; this may lead to an accident causing injury or death. Be alert to the possibility of adverse weather. Take note of weather forecasts and the prevailing weather conditions before setting out on your watercraft.
- As with any water sport, you should not ride your watercraft without someone else near by. If you ride further than swimming distance from shore, you should ride by another boat or watercraft, but make sure you stay a safe distance away. It's good common sense!

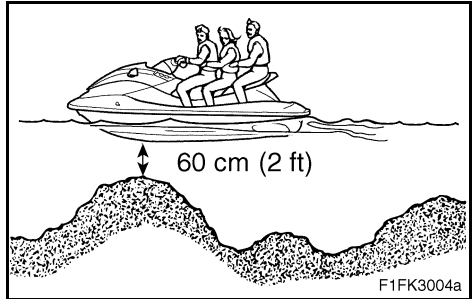

- Never operate in water that is less than 60 cm (2 ft) deep, otherwise you increase your chance of hitting a submerged object, which could result in injury.



K1001

- This watercraft is not equipped with lighting required for night operation. Do not operate the watercraft after sunset or before dawn, otherwise you increase the risk of colliding with another boat, which could result in severe injury or death.

EJU12083

Operation requirements

- All riders must wear a personal flotation device (PFD) that is approved by the appropriate authorities and suitable for personal watercraft use.
- Wear protective clothing. Severe internal injuries can occur if water is forced into body cavities as a result of falling into water or being near the jet thrust nozzle. Normal swimwear does not adequately protect against forceful water entry into rectum or vagina. All riders must wear a wetsuit bottom or clothing that provides equivalent protection. Such clothing includes thick, tightly woven, sturdy and snug-fitting apparel such as denim, but does not include spandex or similar fabrics, like those used in bicycle shorts.

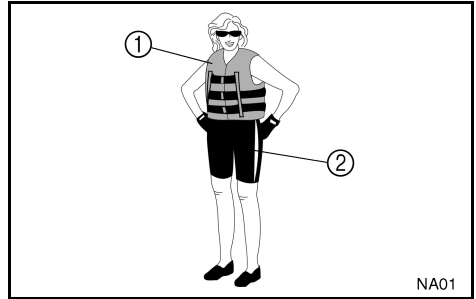

NA01

① Authority-approved PFD

② Wetsuit bottom

- Eye protection is recommended to keep wind, water, and glare from the sun out of your eyes while you operate your watercraft. Restraining straps for eyewear are made which are designed to float should your eyewear fall in the water. Footwear and gloves are recommended.



- You must decide whether to wear a helmet while you ride for recreation. You should know that a helmet could help protect you in certain kinds of accidents and that it could injure you in others.

A helmet is designed to provide some head protection. Although helmets cannot protect against all foreseeable impacts, a helmet might reduce your injuries in a collision with a boat or other obstacle.

A helmet may have potential safety hazards, as well. Falling into the water could risk the chance of the helmet catching water, commonly known as “bucketing,” and the resulting strain on your neck could cause choking, severe and permanent neck injuries, or death. A helmet could also increase the risk of an accident if it reduces your vision or hearing, or if it distracts you or increases your fatigue.

How should you decide if a helmet’s potential safety benefits outweigh its potential risks for you? Consider your particular riding conditions. Consider factors such as your riding environment and your riding style and ability. Also consider the likelihood of traffic congestion, and the water surface conditions. If you decide to wear a helmet based upon your riding circumstances, choose one carefully. Look for a helmet designed for personal watercraft use, if possible. If you will be engaging in closed-course competition, follow the helmet requirements of the sanctioning organization.



- NEVER operate the watercraft after consuming alcohol or taking other drugs.
- For reasons of safety and proper care of the watercraft, always perform the pre-operation checks listed on page 3-5 before operating the watercraft.
- The operator and passengers should always keep both feet in the footwell when the watercraft is in motion. Lifting your feet increases your chances of losing your balance, and your feet being hit by objects outside the watercraft. Do not give a ride to children if their feet cannot reach the floor of the footwell.



- The passengers should hold on firmly, either to the person in front of them or to the handgrip provided.
- Always consult your doctor on whether it is safe for you to ride this watercraft if you are pregnant or in poor health.



- Do not attempt to modify this watercraft! Modifications to your watercraft may reduce safety and reliability, and render the watercraft unsafe or illegal for use.

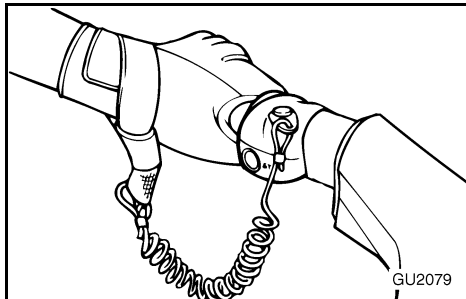

- Attach the engine shut-off cord (lanyard) to wrist and keep it free from the handlebars so that the engine stops if the operator falls off. After riding, remove the engine shut-off cord from the watercraft to avoid accidental starting or unauthorized use by children or others.
- Scan carefully for swimmers and stay away from swimming areas. Swimmers are hard to see and you could accidentally hit someone in the water.
- Avoid being hit by another boat! You should always take the responsibility to watch for traffic; other boaters may not be watching for you. If they do not see you, or you maneuver more quickly than other boaters expect, you risk a collision.
- Maintain a safe distance from other boats or watercraft, and also watch for boats' ski ropes or fishing lines. Obey the "Safe boating rules," and be sure to check behind you before making a turn. (See Safe boating rules on page 1-17.)

EJU01382

Recommended equipment

The following items should be carried on board your watercraft:

- Sound-signaling device
You should carry a whistle or other sound-signaling device that can be used to signal other boats.
- Visual distress signals
It is recommended that an authority-approved pyrotechnic device be stored in a waterproof container on your watercraft. A mirror can also be used as an emergency signal. Contact your Yamaha dealer for more information.
- Watch
A watch is helpful so you will know how long you have been operating.
- Towline
A towline can be used to tow a disabled watercraft in an emergency.



EJU01003

Hazard information

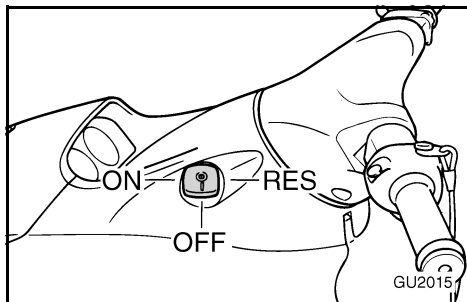

- When transporting or storing your watercraft, always place the fuel cock knob in the “OFF” position, otherwise gasoline may overflow from the carburetor.
- Never start the engine or let it run for any length of time in an enclosed area. Exhaust fumes contain carbon monoxide, a colorless, odorless gas that may cause loss of consciousness and death within a short time. Always operate the watercraft in an open area.

EJU01980

Watercraft characteristics

- Jet thrust turns the watercraft. Releasing the throttle completely produces only minimum thrust. If you are traveling at speeds above trolling, you will have rapidly decreasing ability to steer without throttle. You may still have some turning ability immediately after releasing the throttle, but once the engine slows down, the watercraft will no longer respond to handlebar input until you open the throttle again or you reach a trolling speed. Practice turning in an open area without obstructions until you have a good feel for this maneuver.
- This watercraft is water-jet propelled. The jet pump is directly connected to the engine. This means that jet thrust will produce some movement whenever the engine is running. There is no “neutral” position.



- Keep away from intake grate ① while the engine is on. Items such as long hair, loose clothing, or PFD straps can become entangled in moving parts resulting in severe injury or drowning.
- Never insert any object into the jet thrust nozzle ② while the engine is running. Severe injury or death could result from coming in contact with the rotating parts of the jet pump.

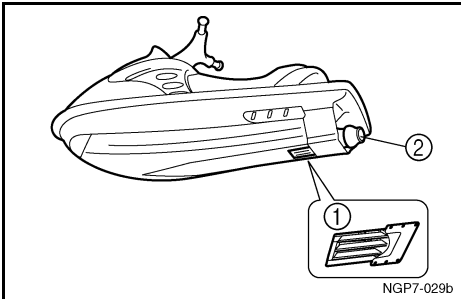

- Stop the engine and remove the clip ③ from the engine shut-off switch ④ before removing any debris or weeds, which may have collected around the jet intake.

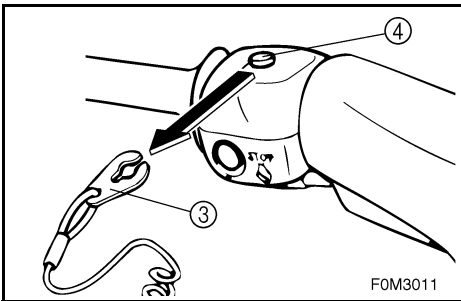

EJU01896

Water-skiing

You can use the watercraft for water-skiing if it has the seating capacity to carry the operator, a rearward-facing spotter, and the water-skier when he or she is not skiing.

The watercraft must also have a cleat ① designed to pull a ski tow rope; do not attach the tow rope to any other location.

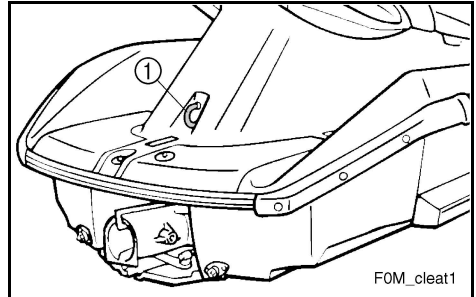

It is the watercraft operator's responsibility to be alert to the safety of the water-skier and others. Know and follow all local water-skiing regulations in effect for the waters in which you will be operating.

The operator should be comfortable carrying passengers before attempting to pull a skier.

The following are some important considerations for minimizing risks while water-skiing.

- The skier should wear an approved PFD, preferably a brightly colored one so boat operators can see the skier.
- The skier should wear protective clothing. Severe internal injuries can occur if water is forced into body cavities as a result of falling into the water. Normal swimwear does not adequately protect against forceful water entry into rectum or vagina. The skier should wear a wetsuit bottom or clothing that provides equivalent protection.



- A second person should be on board as a spotter to watch the skier; in many places it is required by law. Let the skier direct the operator's control of speed and direction with hand signals.

The spotter should sit securely on the passenger seat and hold onto the hand-grip ② with one hand and the finger grip ③ with the other hand, and place his/her feet firmly on the footrest ④ for proper balance while facing to the rear to watch the skier's hand signals and his or her condition.

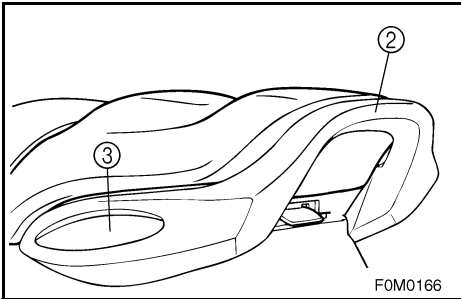
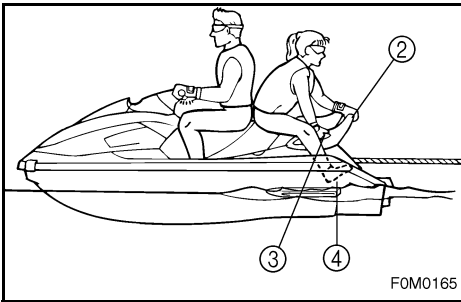

- Your control while pulling a skier is affected by the skier's ability, as well as water and weather conditions.

- When preparing to pull a skier, operate the watercraft at the slowest possible speed until the watercraft is well away from the skier and slack in the towrope is taken up. Make sure that the rope is not looped around anything.

After checking that the skier is ready and that there is no traffic or other obstacles, apply enough throttle to raise the skier.

- Make smooth, wide turns. The watercraft is capable of very sharp turns, which could exceed the abilities of the skier. Keep the skier at least 50 m (150 ft), about twice the distance of a standard towrope, from any potential hazard.
- Be alert to the hazard of the towrope handle snapping back at the watercraft when the skier falls or is unable to get up on the skis.
- Towing heavy or bulky objects other than skiers, such as another boat or watercraft, can cause loss of steering control and create a hazardous condition. If you must tow another boat in an emergency situation, operate slowly and cautiously.



Safe boating rules

Your Yamaha watercraft is legally considered a powerboat. Operation of the watercraft must be in accordance with the rules and regulations governing the waterway on which it is used.

Enjoy your watercraft responsibly

You share the areas you enjoy when riding your watercraft with others and with nature. So your enjoyment includes a responsibility to treat these other people, and the lands, waters, and wildlife with respect and courtesy.

Whenever and wherever you ride, think of yourself as the guest of those around you. Remember, for example, that the sound of your watercraft may be music to you, but it could be just noise to others. And the exciting splash of your wake can make waves others won't enjoy. Avoid riding close to shoreline homes and waterfowl nesting areas or other wildlife areas, and keep a respectful distance from fishermen, other boats, swimmers, and populated beaches. When travel in areas like these is unavoidable, ride slowly and obey all laws.

Remember that pollution can be harmful to the environment. Do not refuel or add oil where a spill could cause damage to nature. Remove your watercraft from the water and move it away from the shoreline before refueling. And keep your surroundings pleasant for the people and wildlife that share the waterways: don't litter!

When you ride responsibly, with respect and courtesy for others, you help ensure that our waterways stay open for the enjoyment of a variety of recreational opportunities.

EJU01007

FEATURES AND FUNCTIONS



Location of main components2-1

Operation of controls and other functions	2-4
Rear seat	2-4
Front seat	2-5
Hood	2-6
Fuel tank filler cap	2-7
Oil tank filler cap	2-7
Fuel cock knob	2-8
Engine stop switch	2-9
Engine shut-off switch	2-9
Choke knob	2-9
Throttle lever	2-10
Start switch	2-10
Cooling water pilot outlet	2-11
Steering system	2-11
Handgrip	2-12
Finger grip	2-12
Engine overheat warning system	2-13
Oil level warning lamp	2-14
Storage compartments	2-15



Location of main components

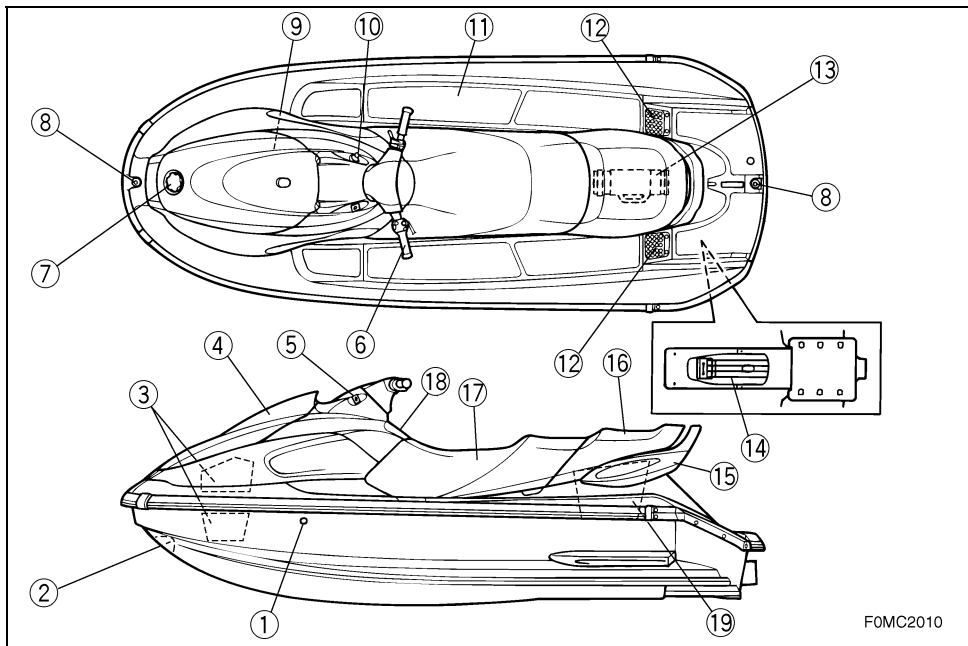

F0MC2010

- ① **Cooling water pilot outlet**
Use to verify cooling water flow.
- ② **Bow eye**
Use to attach rope for transporting, mooring or towing the watercraft in an emergency.
- ③ **Front storage compartment**
- ④ **Hood**
- ⑤ **Fuel cock knob**
Use to select either normal or reserve fuel flow from the fuel tank to the carburetors, or to shut off fuel flow.
- ⑥ **Handlebars**
Use to control direction.
- ⑦ **Fuel tank filler cap**
- ⑧ **Rope hole**
Use to attach a rope for mooring only.
- ⑨ **Oil tank filler cap**
- ⑩ **Choke knob**
Use to start a cold engine.
- ⑪ **Footwell**
Use to place feet for balance.
- ⑫ **Footrest**
To keep proper balance while facing to the rear to watch the skier.
- ⑬ **Fire extinguisher container**
Use to store the fire extinguisher.
- ⑭ **Intake grate**
Prevents debris from getting into the jet pump.
- ⑮ **Handgrip**
Use for support when boarding the watercraft or when seated facing rearward and acting as a spotter for a water-skier.
- ⑯ **Rear seat**
- ⑰ **Front seat**
- ⑱ **Glove compartment**
- ⑲ **Seat storage compartments**

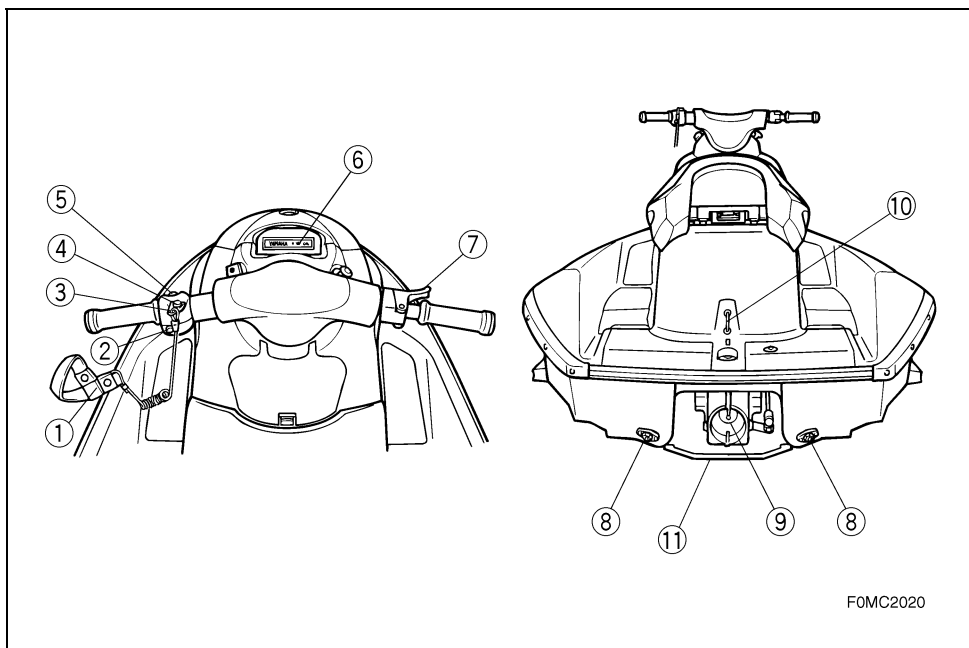

F0MC2020

- ① **Engine shut-off cord (lanyard)**
Attach to wrist so that the engine stops if the operator falls off the watercraft.
- ② **Engine stop switch**
Push to stop the engine normally.
- ③ **Clip**
Insert into the engine shut-off switch to enable starting of the engine.
Remove to stop the engine or prevent accidental starting of the engine or unauthorized use of the watercraft.
- ④ **Engine shut-off switch**
Remove the clip to stop the engine and disable it from starting.
- ⑤ **Start switch**
Push to start the engine.
- ⑥ **Oil level warning lamp**
- ⑦ **Throttle lever**
Use to accelerate and decelerate.
- ⑧ **Stern drain plugs**
Use to drain water in the bilge when the watercraft is on dry land.
- ⑨ **Jet thrust nozzle**
Changes the direction of jet thrust according to handlebar position.
- ⑩ **Cleat**
Use to attach a towrope for pulling water-skier or a rope mooring the watercraft.
- ⑪ **Ride plate**

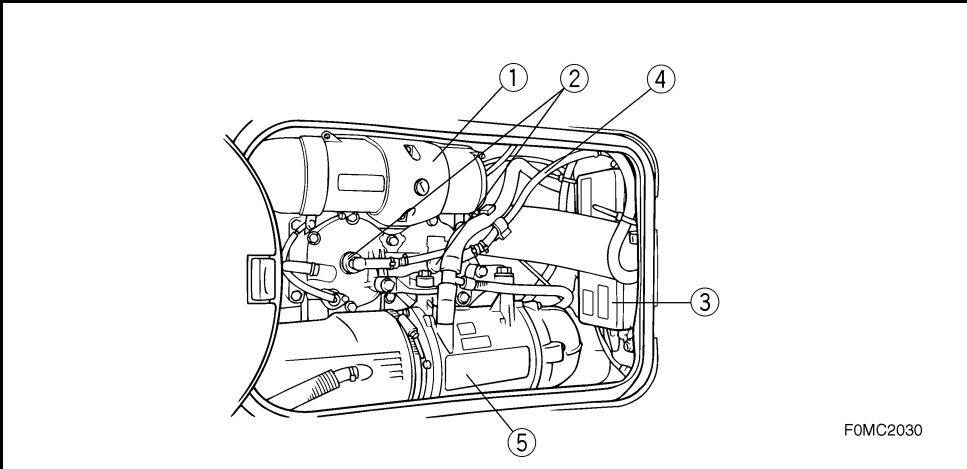

F0MC2030

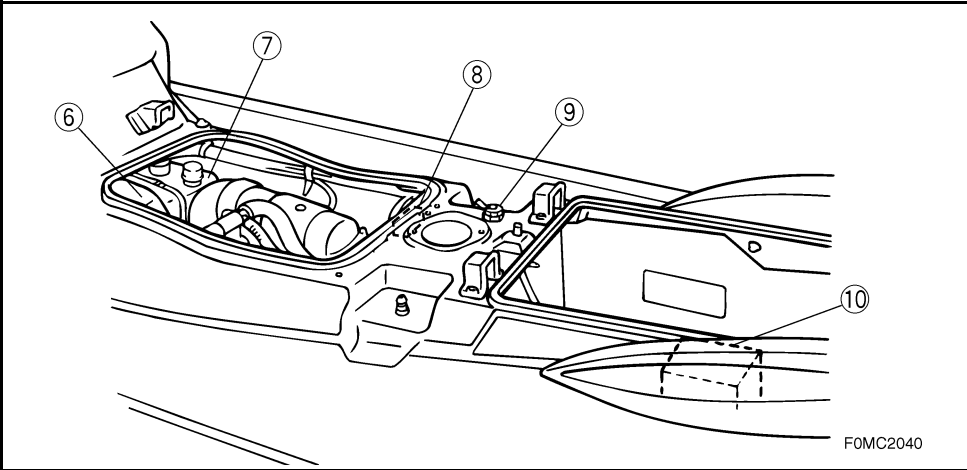

F0MC2040

- ① **Silencer**
Prevents water from getting into the engine and reduces air intake noise.
- ② **Spark plugs/caps**
- ③ **Electrical box**
Protects electrical components from water.
- ④ **Spark plug lead**
- ⑤ **Muffler**
- ⑥ **Fuel tank**
- ⑦ **Oil tank**
- ⑧ **Fuel filter**
- ⑨ **Flush hose connector**
Use to flush the engine cooling water passages.
- ⑩ **Battery**

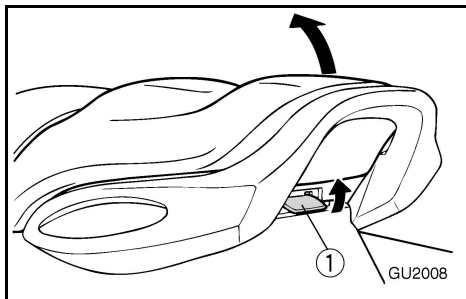

EJU01009

Operation of controls and other functions

EJU01211

Rear seat

To remove the rear seat:

Pull the rear seat latch ① up, and then pull the seat off.

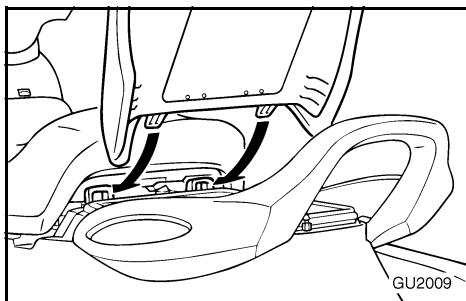

To install the rear seat:

Insert the projections on the front of the seat into the stays on the deck, and then push the rear of the seat down to lock it in place securely.

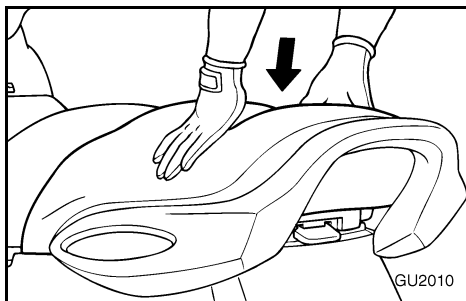



EJU01129

Front seat

To remove the front seat:

Pull the front seat latches ① on both sides up, and then lift the seat and pull it off.

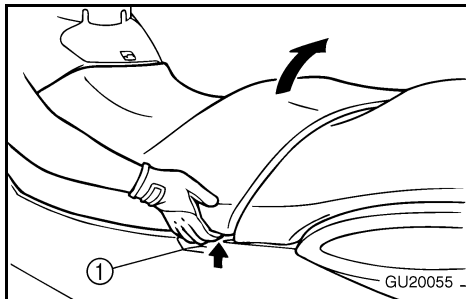

To install the front seat:

Insert the projections on the front of the seat into the stays on the deck, and then push the rear of the seat down to lock it in place securely.

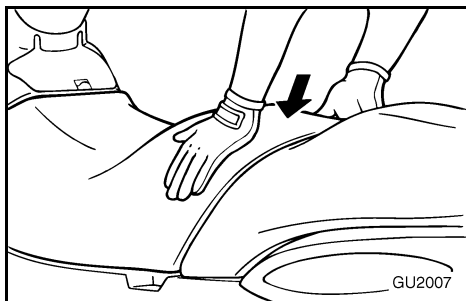
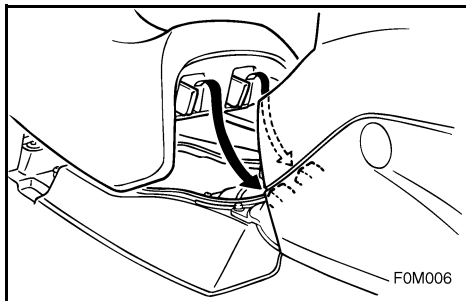



EJU01011

Hood

To open the hood, push the latch ① down, and then lift the hood up.

To close the hood, push the hood down to lock it in place.

NOTE: _____
Make sure that the hood is properly secured before operating the watercraft.

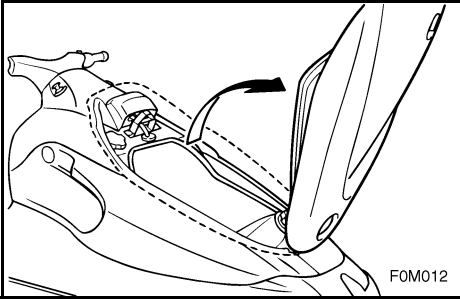
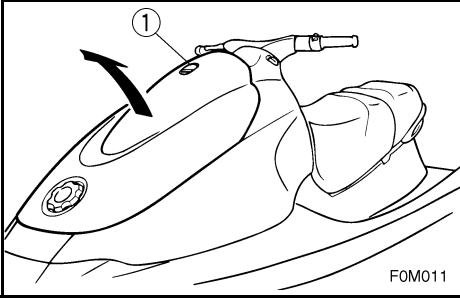

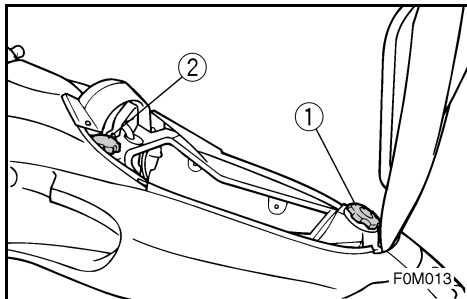

EJU01012

Fuel tank filler cap

To remove the fuel tank filler cap ①, turn it counterclockwise.

NOTE: _____
Make sure that the fuel tank filler cap is properly secured before operating the watercraft.

EJU01214

Oil tank filler cap

To remove the oil tank filler cap:

1. Open the hood. (See page 2-6 for hood.)
2. Turn the filler cap ② counterclockwise.

To install the oil tank filler cap:

Install the filler cap, and then close the hood.

NOTE: _____
Make sure that the oil tank filler cap and hood are properly secured before operating the watercraft.

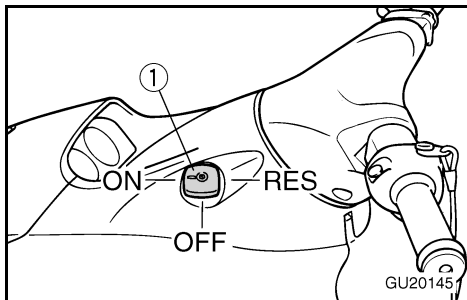

EJU01014

Fuel cock knob

The fuel cock supplies fuel from the fuel tank to the carburetors.

The fuel cock knob ① positions are explained as follows and are shown in the illustration.

OFF:

With the fuel cock knob in this position, fuel does not flow. Always turn the fuel cock knob to this position when the engine is not running.

ON:

With the fuel cock knob in this position, fuel flows to the carburetors. Turn the fuel cock knob to this position when starting the engine and operating the watercraft.

RES:

This indicates reserve. With the fuel cock knob in this position, the fuel reserve is made available. Turn the fuel cock knob to this position if you run out of fuel while operating the watercraft. When this occurs, refuel as soon as possible and be sure to turn the fuel cock knob back to “ON”!

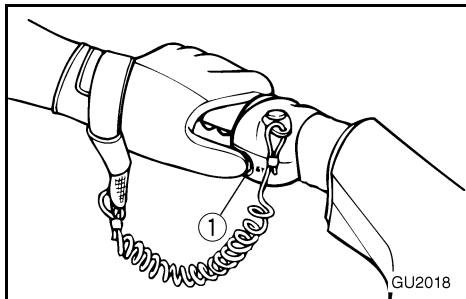

EJU01015

Engine stop switch

Push this switch ① (red button) to stop the engine normally.

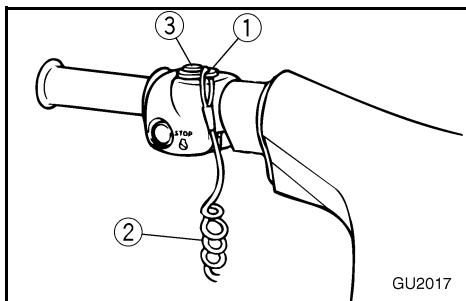

EJU01016

Engine shut-off switch

Insert the clip ①, on the end of the engine shut-off cord ②, under the engine shut-off switch ③ (black button). The engine will stop automatically when the clip is removed from the switch, such as if the operator falls off the watercraft.

⚠WARNING

- Always attach the engine shut-off cord to your wrist and the clip to the engine shut-off switch **BEFORE** starting the engine.
- To prevent accidental starting of the engine or unauthorized use by children or others, always remove the clip from the shut-off switch when the engine is not running.

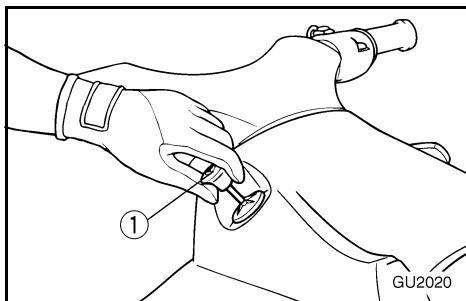
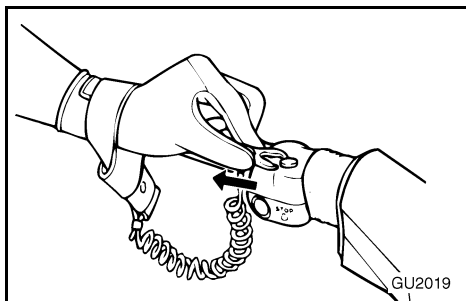

EJU01215

Choke knob

Starting a cold engine requires a richer air-fuel mixture, which is supplied by the choke.

Pull the knob ① out to turn the choke on.
Push the knob in to turn the choke off.

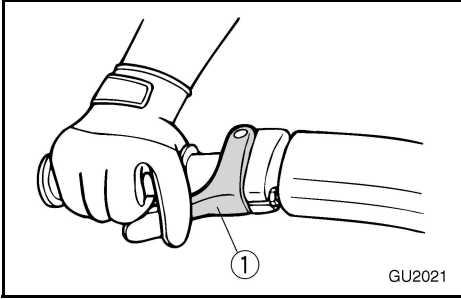

EJU01018

Throttle lever

Squeeze the throttle lever ① to increase engine speed.

Release the throttle lever to decrease engine speed or to return it to the idle position.

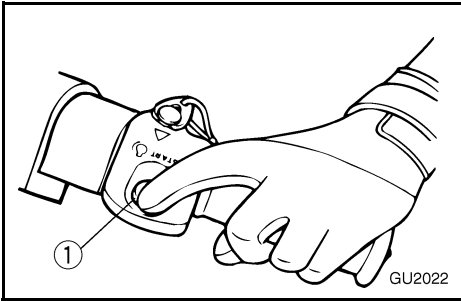

EJU01019

Start switch

Push the start switch ① (green button) to start the engine.

NOTE:

The engine will not start when the clip is removed from the engine shut-off switch.



EJU01130

Cooling water pilot outlet

This watercraft is equipped with a cooling water pilot outlet.

When the engine is running, cooling water is circulated in the engine, and then it is discharged from the pilot outlet.

To check for proper operation of the cooling system, check that water is being discharged from the pilot outlet. If water is not being discharged from the outlet, cooling water may not be circulating in the engine. When this occurs, stop the engine and check for the cause. (See pages 2-13 and 5-4 for further instructions.)

NOTE:

If the cooling water passages are dry, it will take about 20 seconds for the water to reach the outlet after the engine is started.

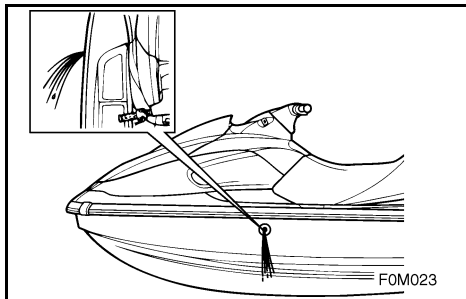

EJU01021

Steering system

Your watercraft can be steered by turning the handlebars ① the same direction you wish to travel.

When the handlebars are turned, the angle of the jet thrust nozzle ② is changed, and the direction of the watercraft is changed accordingly. Since the strength of the jet thrust determines the speed and direction of a turn, the throttle must always be open when attempting a turn, except at trolling speed.

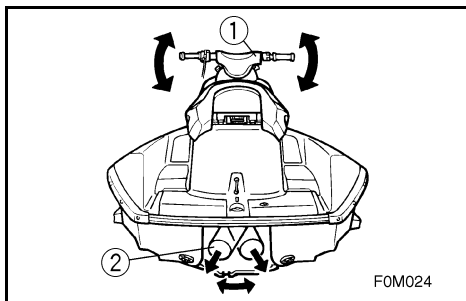

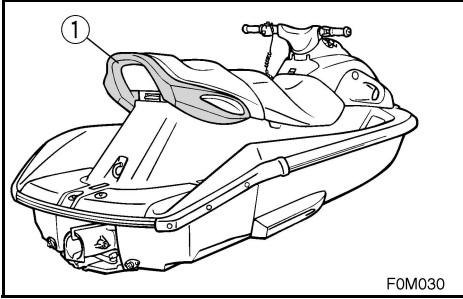

EJU01967

Handgrip

The handgrip ① provides a handhold for boarding the watercraft and for a spotter when facing rearward.

⚠WARNING

Do not use the handgrip to lift the watercraft. The watercraft could fall, which could result in severe injury.

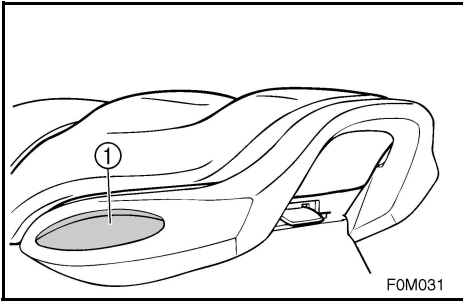

EJU01981

Finger grip

The finger grip ① provides a handhold for a spotter when facing rearward.

⚠WARNING

Do not use the finger grip to lift the watercraft. The watercraft could fall, which could result in severe injury.



EJU01131

Engine overheat warning system

This model is equipped with an engine overheat warning system.

If the engine starts to overheat, the engine speed will be limited to about 3,400 r/min.

When this occurs, check for water discharge at the cooling water pilot outlet. If there is no discharge of water, reduce the engine speed and beach the watercraft, and then check the intake grate and impeller for clogging.

⚠ WARNING

Before attempting to remove weeds or debris from the intake grate or impeller, shut the engine off and remove the clip from the engine shut-off switch. Severe injury or death could result from coming in contact with the rotating parts of the jet pump.

CAUTION:

If you cannot locate and correct the cause of the overheating, consult a Yamaha dealer. Continuing to operate at higher speeds could result in severe engine damage.

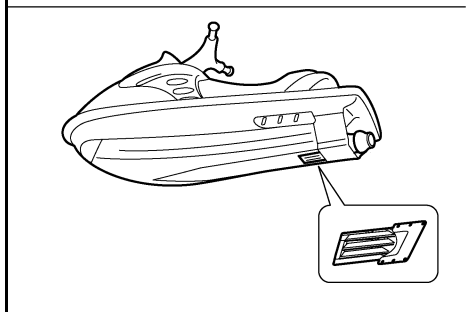
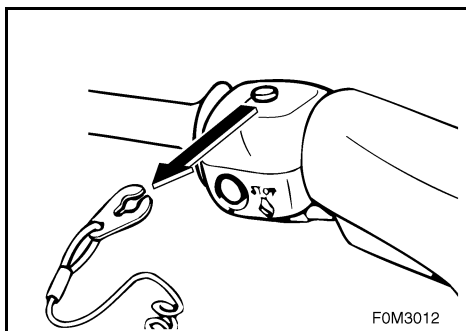
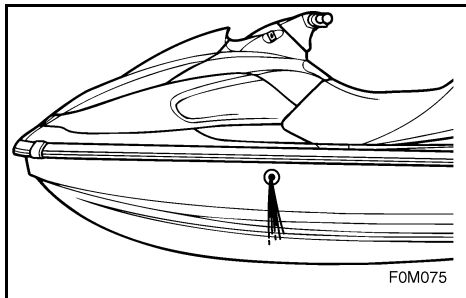

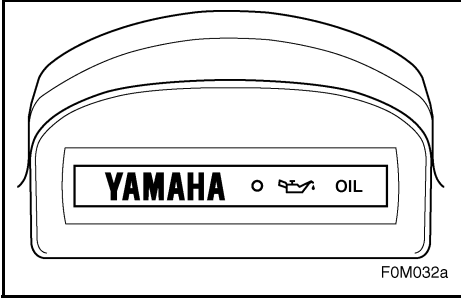

EJU01132

Oil level warning lamp

If the oil remaining in the tank drops to about 1.2 L (0.31 US gal, 0.26 Imp gal) or the oil filter is clogged, the oil level warning lamp begins to blink.

If the oil level warning lamp begins to blink, refill with engine oil as soon as possible.

NOTE: _____

- The lamp will light up for 2 seconds after starting the engine to check the lamp operation.
- If the warning lamp blinks with adequate oil in the tank, check for a clogged oil filter.

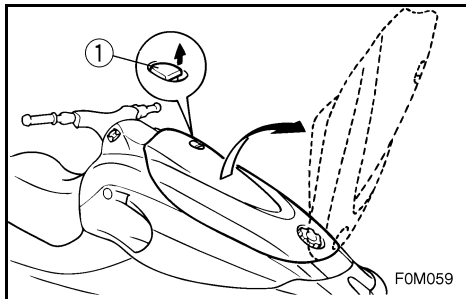

EJU01236

Storage compartments

A front storage compartment, a glove compartment, and seat storage compartments are provided.

NOTE:

- Make sure that the storage compartments are properly secured before operating the watercraft.
- The storage compartments are not designed to be waterproof. If you carry objects that must be kept dry, such as the manuals, put them in a waterproof bag.

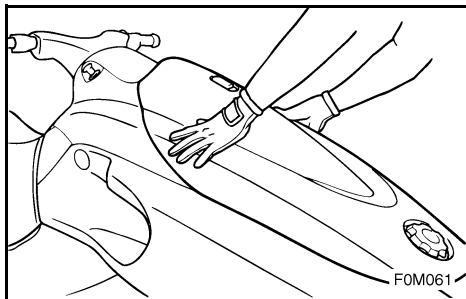

EJU01133

Front storage compartment

Two storage compartments are located at the bow.

To open the front storage compartment, pull the hood latch ① up, and then open the hood.

To close the front storage compartment, push down on the rear of the hood until it latches securely.

NOTE:

The lower storage compartment ③ is provided under the upper storage compartment ②. To access the lower storage compartment, remove the upper storage compartment.

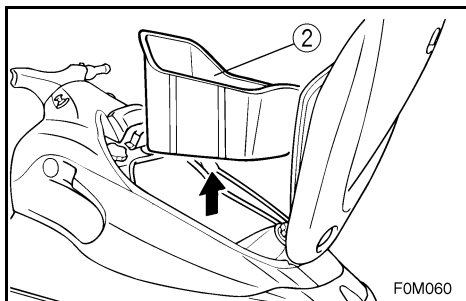

Upper storage compartment:
Capacity: 44 L (4.4 US gal, 3.6 Imp gal)
Load limit: 5 kg (11 lb)

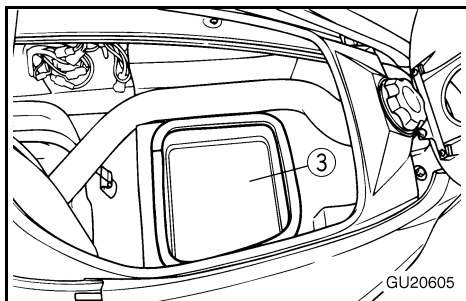

CAUTION:

Store only soft, light weight objects, such as rope or rags, in the lower storage compartment. Storing hard or heavy objects, such as tools or cans, may damage the compartment.

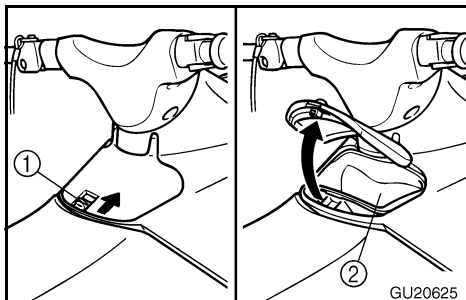

EJU01134

Glove compartment

A glove compartment ② is located in front of the seat.

To open the glove compartment, slide the latch ① and then lift up the lid. To close the glove compartment, push the lid down until it locks securely.

Glove compartment:
Capacity: 1.7 L
(0.45 US gal, 0.37 Imp gal)
Load limit: 1 kg (2.2 lb)

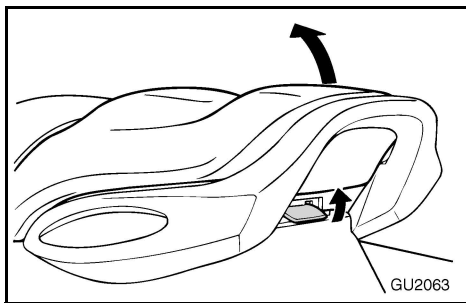

EJU01797

Seat storage compartment

The seat storage compartment ① is located under the rear seat.

To open the seat storage compartment, remove the rear seat. (See page 2-4 for rear seat removal and installation procedures.)

Seat storage compartment:
Capacity: 21.2 L
(5.6 US gal, 4.7 Imp gal)
Load limit: 9 kg (19.8 lb)

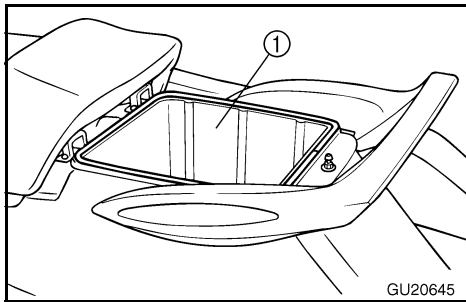



-MEMO-

OPERATION

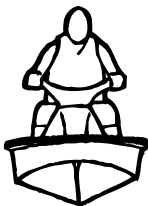

Fuel and oil	3-1
Gasoline	3-1
2-stroke engine oil	3-2
Filling the fuel tank	3-3
Filling the oil tank	3-4
Pre-operation checks	3-5
Pre-operation check list	3-5
Pre-operation check points	3-6
Operation	3-14
Engine break-in	3-14
Starting the engine	3-16
Stopping the engine	3-19
Leaving the watercraft	3-19
Operating your watercraft	3-20
Getting to know your watercraft	3-20
Learning to operate your watercraft	3-20
Riding watercraft with passengers	3-21
Starting the watercraft	3-22
Boarding and starting in deep water	3-24
Capsized watercraft	3-27
Turning the watercraft	3-29
Stopping the watercraft	3-31
Beaching the watercraft	3-32
Docking the watercraft	3-32
Rough water operation	3-33
Post-operation checks	3-34
Transporting	3-36



Fuel and oil

This engine uses Yamaha's oil injection system, which provides superior lubrication by ensuring the proper oil ratio for all operating conditions. No fuel premixing is necessary except during the engine break-in period. Simply pour gasoline into the fuel tank and oil into the oil tank.

Gasoline

⚠WARNING

GASOLINE AND ITS VAPORS ARE HIGHLY FLAMMABLE AND EXPLOSIVE!

- Do not smoke when refueling, and keep away from sparks, flames, or other sources of ignition.
- Stop engine before refueling.
- Refuel in a well-ventilated area with the watercraft in a horizontal position.
- Do not stand or sit on the watercraft while refueling in case of fire.
- Take care not to spill gasoline. If gasoline spills, wipe it up immediately with dry rags. Always properly dispose of gasoline-soaked rags.
- Avoid overfilling the fuel tank. Stop filling when the fuel level just reaches the bottom of the filler tube. Do not fill up the filler tube because fuel expands as it warms up and could overflow. If temporarily leaving the watercraft with a full fuel tank, do not leave it in direct sunlight. Leave it in a well-ventilated area with the watercraft in a horizontal position.
- Tighten the filler cap securely after refueling.
- If you should swallow some gasoline, inhale a lot of gasoline vapor, or get gasoline in your eyes, get immediate medical attention.



- If any gasoline spills onto your skin, immediately wash with soap and water. Change clothing if gasoline spills on it.

CAUTION:

Use only fresh gasoline that has been stored in clean containers.

Recommended gasoline:

Regular unleaded gasoline with a minimum octane rating of
 86 (Pump octane number) = $(R+M)/2$
 90 (Research octane number)

EJU01832

Gasohol

There are two types of gasohol: gasohol containing ethanol and that containing methanol.

Gasohol containing ethanol can be used if ethanol content does not exceed 10% and the fuel meets minimum octane ratings.

Gasohol containing methanol is not recommended by Yamaha because it can cause fuel system damage or engine performance problems.

EJU10441

2-stroke engine oil

Recommended engine oil:
YAMALUBE 2-W oil

If YAMALUBE 2-W oil is not available, another 2-stroke engine oil with an NMMA-certified TC-W3 rating may be used.

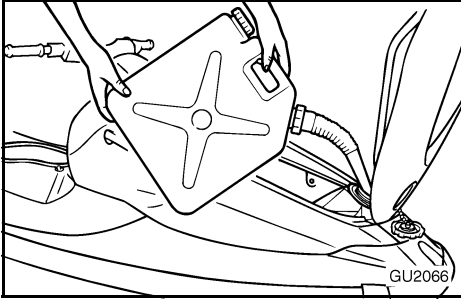

EJU01135

Filling the fuel tank

CAUTION:

Be careful when refueling. Avoid getting water or other contaminants in the fuel tank. Contaminated fuel can cause poor running or engine damage.

1. Open the hood and remove the front storage compartment. Also, remove all seats, so you can watch the fuel level. (See page 2-6 for hood, and pages 2-4 and 2-5 for seats.)
2. Open the fuel tank filler cap, and slowly add fuel to the fuel tank.
3. Stop filling when the fuel just reaches the bottom of the filler tube on the fuel tank. Do not fill into the filler tube, because fuel could spill out.

Fuel tank capacity:

Total: 50 L (13.2 US gal, 11 Imp gal)

Reserve: 12 L (3.2 US gal, 2.6 Imp gal)



EJU01328

Filling the oil tank

⚠ WARNING

- Do not add gasoline to the oil tank. Fire or explosion could result.
- Oil in the bilge is a serious fire hazard. Wipe up any spilled oil immediately.

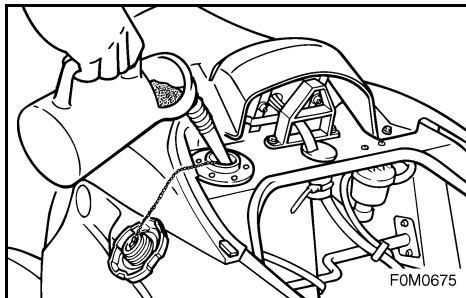

CAUTION:

Do not allow the oil tank to become completely empty. If the oil tank becomes empty the oil injection pump must be bled to ensure proper oil flow, otherwise engine damage may occur. If bleeding of the oil pump is necessary, have a Yamaha dealer bleed it.

1. Open the hood and remove the front storage compartment. Also, remove all seat, so you can watch the oil level. (See page 2-6 for hood, and pages 2-4 and 2-5 for seats.)
2. Open the oil tank filler cap, and very slowly add engine oil to the oil tank.
3. Stop pouring when the oil just reaches the bottom of the filler tube.

Oil tank capacity:
3.8 L (1.0 US gal, 0.8 Imp gal)



EJU01346

Pre-operation checks

EJU01347

Pre-operation check list

Before operating this watercraft, perform the checks in the following check list. See the accompanying text in this chapter for details on how to perform the checks.

⚠ WARNING

If any item in the pre-operation check list is not working properly, have it inspected and repaired before operating the watercraft, otherwise an accident could occur.

ITEM	ROUTINE	PAGE
Engine compartment	Remove all seats and the front storage compartment to ventilate the engine compartment. Check for fuel vapors and loose electrical connections.	3-6
Bilge	Check for water and fuel and remove if necessary.	3-8
Stern drain plugs	Check for proper installation.	3-8
Throttle lever	Check that the throttle lever springs back smoothly.	3-11
Steering system	Check for proper operation.	3-11
Fuel and oil	Check fuel and oil levels and add if necessary. Check the hoses and tanks for leakage.	3-7
Water separator	Check for water and drain if necessary.	3-7
Battery	Check electrolyte level and battery condition.	3-9
Hood	Check that the hood is properly secured.	2-6
Front and rear seats	Check that the seats are properly secured.	2-4–2-5
Hull and deck	Check the hull and deck for cracks or other damage.	3-6
Jet unit	Check for debris and remove if necessary.	3-12
Fire extinguisher	Check condition and replace if necessary.	3-10
Engine shut-off cord	Check condition and replace if frayed or broken.	3-12
Switches	Check the start switch, engine stop switch, and engine shut-off switch for proper operation.	3-13
Cooling water pilot outlet	Check that water is discharged while the engine is running and the watercraft is in the water.	3-12

NOTE:

Pre-operation checks should be made thoroughly each time the watercraft is used. This procedure can be completed in a short time. It is worth the time spent to assure safety and reliability.

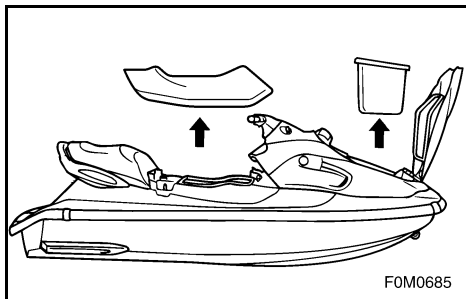

EJU01048

Pre-operation check points

EJU01728

Engine compartment

Ventilate the engine compartment before each use.

To ventilate the engine compartment, remove the front seat and front storage compartment. (See page 2-5 for front seat, and 2-15 for front storage compartment.) Allow the engine compartment to remain open for a few minutes to allow any fuel vapors to escape. Also, check for loose electrical connections.

⚠WARNING

Failure to ventilate the engine compartment could result in fire or explosion. Do not start the engine if there is a fuel leak or a loose electrical connection.

EJU20570

Hull and deck

Check the hull and deck for cracks or other damage. If any damage is found, have a Yamaha dealer repair the watercraft.



EJU01242

Fuel and oil systems

Check the fuel system for leakage, cracks or malfunctions before each use. (See page 4-10 for check points and correct procedures.)

1. Remove the fuel tank filler cap to release any pressure that might have built up in the fuel tank.
2. Remove all seats and front storage compartment. (See pages 2-4 and 2-5 for front and rear seat, and 2-15 for front storage compartment.)
3. Check the fuel and oil levels in the tanks and replenish if necessary. (See pages 3-3 and 3-4 for filling instructions.)

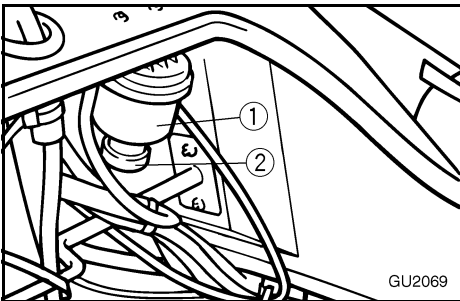

EJU01961

Water separator

Check the water separator ① for water. Normally the water separator is empty. The water separator retains any water entering through the fuel tank breather hose if the watercraft is capsized.

If water remains in the water separator, drain it by removing the drain screw ②. Place a drain pan under the water separator to catch the draining water or use a dry cloth to soak up any water that could spill into the watercraft. If any water spills into the watercraft, be sure to wipe it up with a dry cloth. Be sure to install the drain screw after draining the water separator.



EJU10531

Bilge

Check for moisture and fuel residue in the bilge.

Excessive water in the bilge can splash into the carburetor and engine which could cause engine damage.

To remove water from the bilge:

1. Remove the stern drain plugs.
2. Raise the bow of the watercraft until the water drains.
3. After the water has drained, wipe the bilge with dry rags to make sure that the bilge is thoroughly dry.
4. Install the drain plugs.

EJU20581

Stern drain plug

Check the stern drain plugs for proper installation.

CAUTION:

- Make sure that the stern drain plugs are tightened securely before launching the watercraft. Otherwise, water may flood the engine compartment and cause the watercraft to submerge.
- Clean any foreign materials, such as dirt or sand, from the drain plug threads before installing the drain plugs. Otherwise, the drain plugs may be damaged and water may enter the engine compartment.

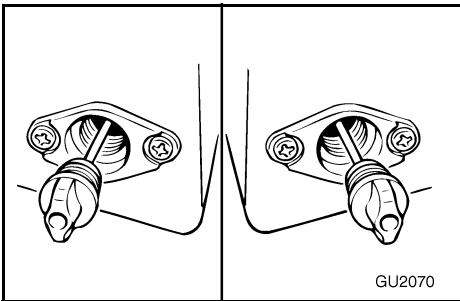



EJU01969

Battery

Check the battery condition and the electrolyte level.

Check that the battery leads are tightened securely and there is no corrosion on the battery terminals.

⚠WARNING

- The battery must always be fully charged and in good condition. Loss of battery power may leave you stranded. Never operate the watercraft if the battery does not have sufficient power to start the engine or if it shows any other signs of decreased power.
- Be sure to connect the breather hose to the battery. Fire or explosion could result if the breather hose is damaged, obstructed, or not connected properly.

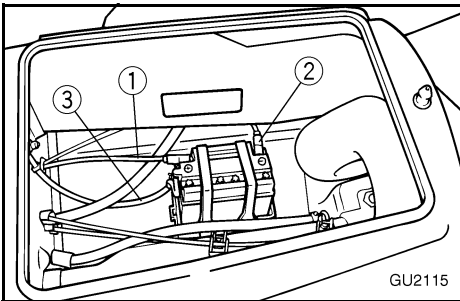

Make sure that the battery is securely held in place.

- ① Positive (+): Red lead
- ② Negative (-): Black lead
- ③ Breather hose



EJU01136

Fire extinguisher

Check that there is a full fire extinguisher on board. The fire extinguisher container ① is located on the underside of the rear seat. (See page 2-4 for rear seat removal procedures.)

To open the fire extinguisher container cap ②, turn it counterclockwise.

After inserting the fire extinguisher, make sure that the container cap is tightened securely.

Install the fire extinguisher container on the seat and secure it with the bands ③.

NOTE:

- See the instructions supplied by the fire extinguisher manufacturer for checking the fire extinguisher. Always keep the extinguisher in the fire extinguisher container.
- Always carry a fire extinguisher on board. A fire extinguisher is not standard equipment with this watercraft. If you do not have one, contact a Yamaha dealer or a fire extinguisher dealer to obtain one meeting the proper specifications.

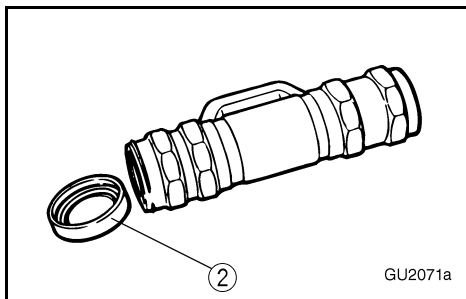
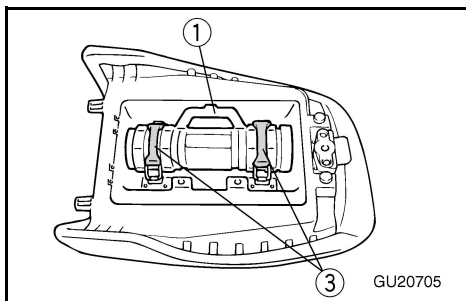
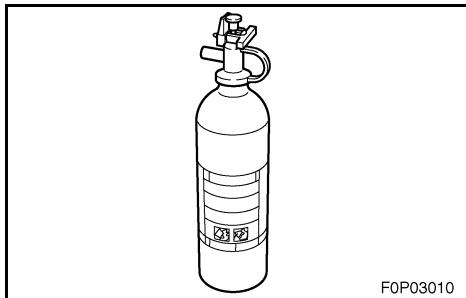

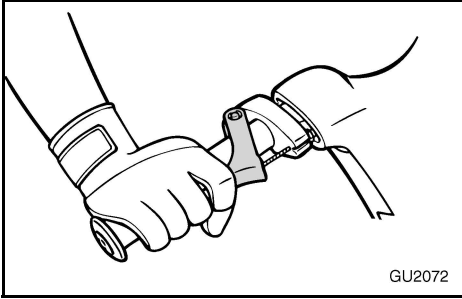

EJU01834

Throttle

Squeeze and release the throttle lever several times to make sure that there is no hesitation in its travel. It should be smooth over the complete range, and spring back to the idle position when released.

⚠WARNING

Before starting the engine, always check the operation of the throttle lever.

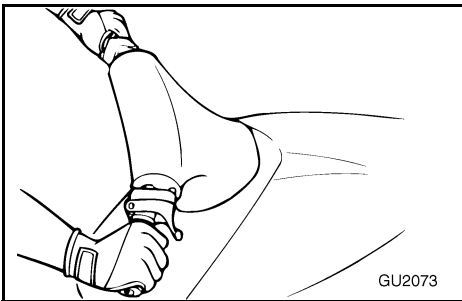

EJU01057

Steering system

Check for looseness in the handlebars.

Turn them as far as possible to the right and left to make sure that operation is smooth and unrestricted throughout the whole range. Make sure that the jet thrust nozzle also changes directions as the handlebars are turned, and that there is no free play between the handlebars and the jet thrust nozzle.

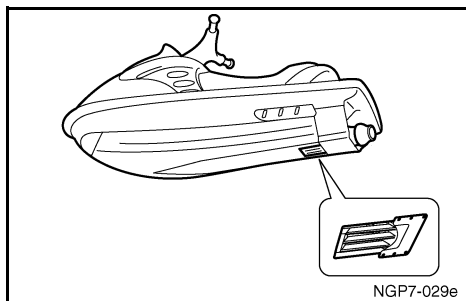
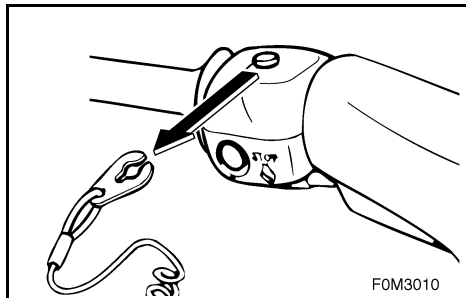

EJU01058

Jet unit

Carefully check the jet intake for weeds, debris, or anything else that might restrict the intake of water. If the intake is clogged, cavitation could occur, reducing jet thrust, and possibly damaging the jet pump.

In some cases, the engine may overheat because of lack of cooling water, and damage to the engine could result. Engine cooling water is fed to the engine by the jet pump. (See page 5-4 for jet intake cleaning procedures.)

⚠ WARNING

- Keep away from intake grate while engine is on. Items such as long hair, loose clothing, or PFD straps can become entangled in moving parts resulting in severe injury or drowning.
- Stop the engine and remove the clip from the engine shut-off switch before removing any debris or weeds, which may have collected around the jet intake.

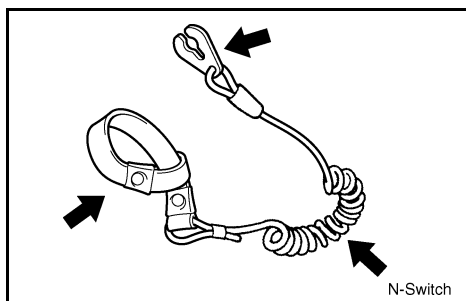

EJU01059

Engine shut-off cord (lanyard)

Check that the engine shut-off cord is not frayed or broken. If the cord is damaged, replace it; never try to repair it or tie it together.

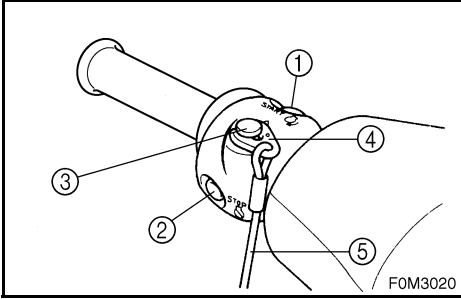

EJU18351

Switches

CAUTION:

Do not run the engine for more than 15 seconds on land without supplying water. The engine can overheat.

Check the start switch, the engine stop switch, and the engine shut-off switch for proper operation.

Push the start switch ① to start the engine. As soon as the engine starts running, push the engine stop switch ② to verify that the engine stops immediately. Restart the engine, and then pull the engine shut-off cord ⑤ to remove the clip ④ from the engine shut-off switch ③ to verify that the engine stops immediately. (See pages 2-9 to 2-10 for information on proper operation of the start switch, the engine stop switch, and the engine shut-off switch.)

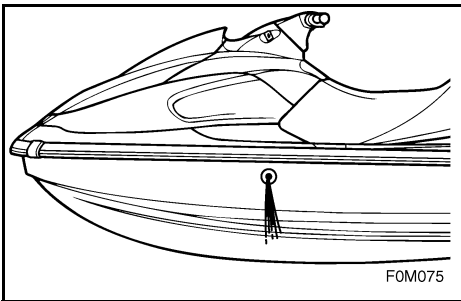

EJU01320

Cooling water pilot outlet

Check that water comes out from the outlet while the engine is running and the watercraft is in the water.



Operation

⚠ WARNING

Before operating your watercraft, become familiar with all controls. Consult your Yamaha dealer about any control or function you do not fully understand. Failure to understand how controls work could cause an accident or prevent you from avoiding an accident.

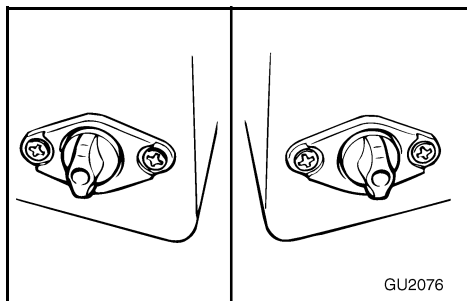

CAUTION:

Make sure that the stern drain plugs are securely tightened before launching the watercraft.

Engine break-in

The engine break-in period is essential to allow the various components of the engine to wear and polish themselves to the correct operating clearances. This ensures proper performance and promotes longer component life.

CAUTION:

- For the first tankful of operation, pre-mix a 50:1 mixture of fuel and oil (in addition to the oil in the oil tank).
- After break-in, use straight gasoline for normal operation.

1. Launch the watercraft and start the engine. (See page 3-16 for engine starting procedures.)
2. Run the engine at the lowest possible speed for 5 minutes.



3. Gradually open the throttle to 3/4 or less.
4. Continue operation at 3/4 throttle or less until the first tankful of fuel has been used.
5. Fill the tank with straight gasoline, and then proceed with normal operation.

CAUTION:

Failure to follow the engine break-in procedure properly can result in severe damage to the engine.



EJU01137

Starting the engine

⚠WARNING

Never start the engine or let it run for any length of time in an enclosed area. Exhaust fumes contain carbon monoxide, a colorless, odorless gas that may cause loss of consciousness and death within a short time. Always operate the watercraft in an open area.

1. Launch the watercraft in water free from weeds and debris and at least 60 cm (2 ft) deep.

⚠WARNING

Never operate in water that is less than 60 cm (2 ft) deep, otherwise you increase your chance of hitting a submerged object, which could result in injury.

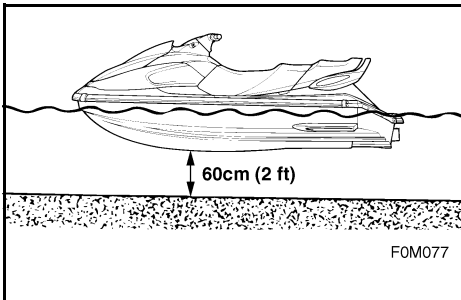

CAUTION:

Never operate in water that is less than 60 cm (2 ft) deep, otherwise pebbles or sand could be sucked into the jet intake, causing impeller damage or engine overheating.

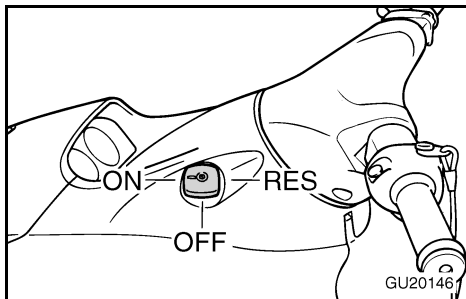

2. Turn the fuel cock knob to the “ON” position.

NOTE:

Before starting the watercraft, after it has been sitting, remove the fuel tank filler cap to release any built-up pressure in the tank due to fuel expansion.

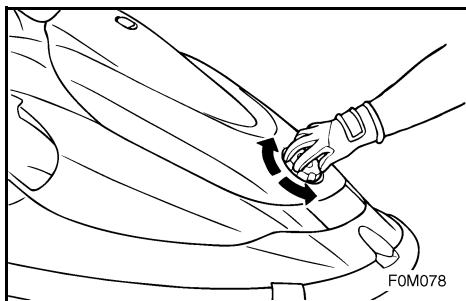

3. Attach the clip ① to the engine shut-off switch ②. Also, attach the engine shut-off cord ③ to your left wrist.

⚠WARNING

Check that the engine shut-off cord is not frayed or broken, and keep it free from the handlebars so the engine stops if the operator falls off. The engine shut-off cord may not pull free if wrapped around the handlebars when the operator falls off, allowing the watercraft to continue to run and cause an accident.

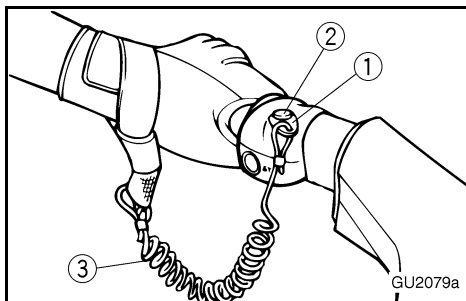
**NOTE:**

It is not possible to start the engine with the clip removed from the engine shut-off switch.

4. Pull and hold the choke knob all the way out to start a cold engine.

NOTE:

The choke should not be used when the engine is warm.

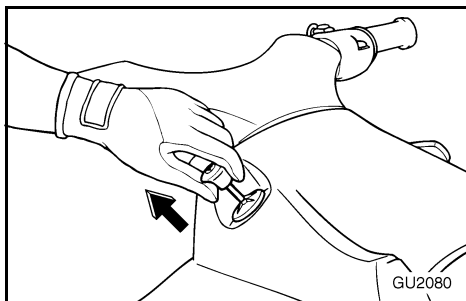

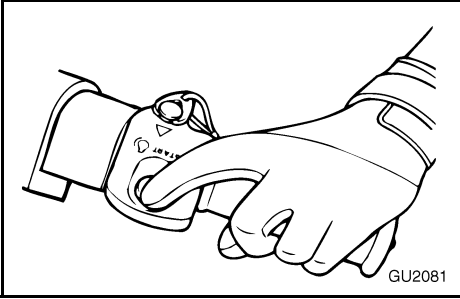

5. While lightly squeezing the throttle lever, push the start switch (green button).

⚠ WARNING

On this watercraft, the engine is connected directly to the jet pump. Starting the engine immediately generates some thrust. Apply only enough throttle to keep the engine running.

6. Release the start switch as soon as the engine starts to run.

CAUTION:

- Never push the start switch while the engine is running.
- Do not operate the start switch for more than 5 seconds, otherwise the battery will be discharged and the engine will not start. Also, the starter motor may be damaged. If the engine does not start in 5 seconds, release the start switch, wait 15 seconds, and try again.

7. After the engine has warmed up, push the choke knob in to its original position.

NOTE:

If the choke knob is left pulled out, the engine will stall.

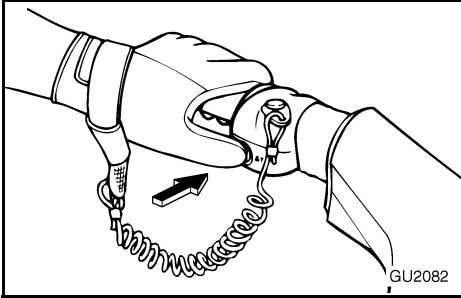

EJU01066

Stopping the engine

To stop the engine, release the throttle lever, and then push the engine stop switch (red button).

⚠WARNING

You need throttle to steer. Shutting off the engine can cause you to hit an obstacle you are attempting to avoid. A collision could result in severe injury or death.

EJU01067

Leaving the watercraft

If leaving the watercraft, remove the engine shut-off cord to reduce the chance of accidental starting or unauthorized use by children or others.



EJU01068

Operating your watercraft

EJU01250

Getting to know your watercraft

Operating your watercraft requires skills acquired through practice over a period of time. Take the time to learn the basic techniques well before attempting more difficult maneuvers.

Operating your new watercraft can be a very enjoyable activity, providing you with hours of pleasure. However, it is essential to familiarize yourself with the operation of the watercraft to achieve the skill level necessary to enjoy riding safely. Before operating this watercraft, read this Owner's/Operator's Manual, the Riding Practice Guide, and all warning and caution labels on the watercraft. Pay particular attention to the safety information on pages 1-9 to 1-16. These materials should give you an understanding of the watercraft and its operation.

Remember: This watercraft is designed to carry the operator and up to 2 passengers. Never exceed the maximum load limit or allow more than 3 persons (or 2 persons if a water-skier is being pulled) to ride the watercraft at one time.

Maximum load: 240 kg (530 lb)
Load is the total weight of cargo, operator and passengers.

EJU01070

Learning to operate your watercraft

Before operating the watercraft, always perform the pre-operation checks listed on page 3-5. The short time spent checking the watercraft will reward you with added safety and reliability.

Check all local laws before operating your watercraft.

Operate defensively at safe speeds and keep a safe distance away from people, objects, and other watercraft. Select a wide area to learn in, where you have good visibility and light boat traffic.

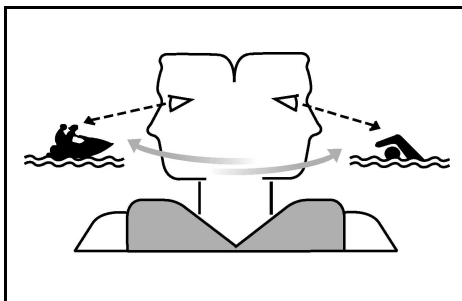

Use the buddy system—operate with someone nearby. Scan constantly for people, objects, and other watercraft. Be alert for conditions that limit your visibility or block your vision of others.

Attach the engine shut-off cord (lanyard) to your wrist and keep it free from the handlebars so that the engine stops if the operator falls off.

Wear a personal flotation device (PFD). All riders must wear an authority-approved PFD that is suitable for personal watercraft use.



Wear protective clothing. Severe internal injuries can occur if water is forced into body cavities as result of falling into the water or being near the jet thrust nozzle. Normal swimwear does not adequately protect against forceful water entry into rectum and vagina. All riders must wear a wetsuit bottom or clothing that provides equivalent protection.

Such clothing includes thick, tightly woven, sturdy and snug-fitting apparel such as denim, but does not include spandex or similar fabrics like those used in bicycle shorts. A full wetsuit can also protect against hypothermia (subnormal body temperature) and abrasions.

Footwear and gloves are recommended.

Eye protection is recommended to keep wind, water, and glare from the sun out of your eyes while you operate your watercraft. Restraining straps for eyewear are made which are designed to float should your eyewear fall in the water.

You should grip the handlebars firmly and keep both feet on the floor of the footwell. Do not attempt to ride with passengers until your operating skills are fully developed.

EJU12512

Riding watercraft with passengers

When 2 or 3 persons (including the operator) are on board, the watercraft handles differently, and is not as easy to maneuver, so operating it requires a higher degree of skill. Before attempting to operate the watercraft with passengers on board, the operator must practice operating the watercraft alone enough to be able to acquire the necessary skills.

The passengers must always wear an authority-approved PFD and a wetsuit bottom or equivalent.

⚠WARNING

Do not apply throttle when anyone is at rear of watercraft. Turn engine off or keep engine at idle. Water and/or debris exiting the jet thrust nozzle can cause severe injury. Passengers should not attempt to board the watercraft if the operator is applying throttle.

Do not give a ride to children whose feet cannot reach the floor of the footwell. The passengers should hold on firmly, either to the person in front of them or to the handgrip provided, and keep both feet on the floor of footwell.

⚠WARNING

When passengers are on board, make sure that they are holding on firmly and have feet in the footwell before you start to accelerate.

When pulling a skier, the spotter should face to the rear while holding the handgrip with both hands. The spotter should always sit astride the seat with his or her feet placed firmly on the footrest for proper balance. Follow all local laws regarding skiing such as skier-down flags, rearward-facing spotter, and other requirements.



EJU01837

Starting the watercraft

⚠ WARNING

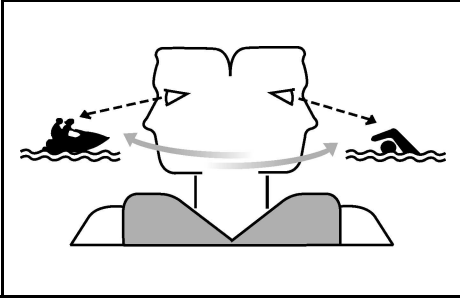

- Scan constantly for people, objects, and other watercraft. Be alert for conditions that limit your visibility or block your vision of others.
- Operate defensively at safe speeds and keep a safe distance away from people, objects, and other watercraft.
- Do not follow directly behind watercraft or other boats. Do not go near others to spray or splash them with water. Avoid sharp turns or other maneuvers that make it hard for others to avoid you or understand where you are going. Avoid areas with submerged objects or shallow water.
- Take early action to avoid collisions. Remember watercraft and other boats do not have brakes. Do not release the throttle when trying to steer away from objects—you need throttle to steer.
- Practice reboarding in shallow water before riding in deep water.

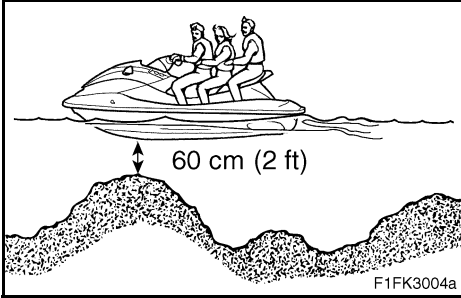

EJU01073

Starting and boarding in shallow water

1. Do not start the engine in less than 60 cm (2 ft) of water. Put the watercraft in water that is deep enough, and then board the watercraft from the side or the rear.
2. Attach the engine shut-off cord to your left wrist, and then install the clip to the engine shut-off switch.
3. Grip the handlebars with both hands, place both feet on the floor of the foot-well, start the engine, and start off.

EJU01074

Starting from a dock

1. Board the watercraft from the side.
2. Attach the engine shut-off cord to your left wrist, and then install the clip to the engine shut-off switch.
3. Push the watercraft away from the dock, grip the handlebars with both hands, place both feet on the floor of the foot-well, start the engine, and start off.



EJU01075

Boarding and starting in deep water

⚠WARNING

- Operator and passenger should practice getting on board in shallow water before riding in deep water. Boarding in deep water requires more skill.
- The fatigue and exposure that could result after unsuccessful attempts to get back on the watercraft may increase the risk of injuries and drowning.

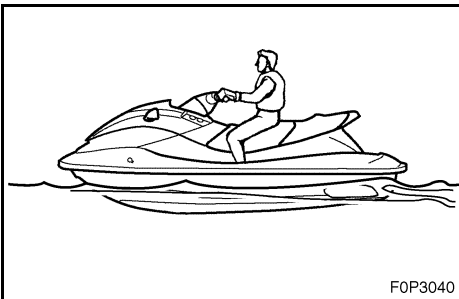
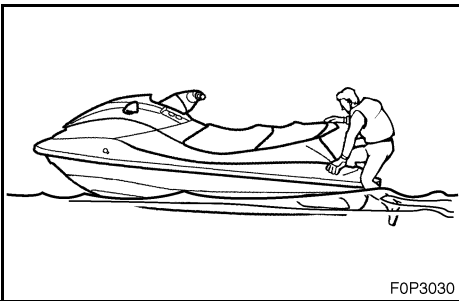
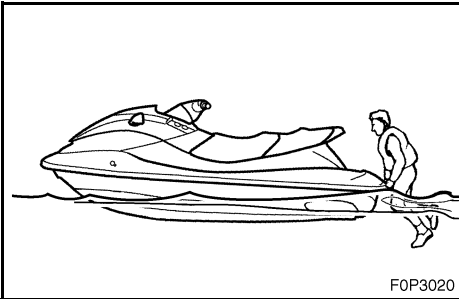

EJU01838

Boarding alone

1. Swim to the rear of the watercraft and place both hands on the boarding platform, pull yourself up, and then grasp the handgrip with one hand.
2. Pull yourself up to a kneeling position on the platform, and then move to the seat and sit astride.
3. Attach the engine shut-off cord to your left wrist, and then install the clip to the engine shut-off switch.
4. Grip the handlebars firmly with both hands, place both feet on the floor of the footwell, start the engine, and then look in all directions before starting off.

⚠WARNING

Before starting off, make sure that there are no boats, obstructions, or swimmers around you.



EJU01849

Boarding with passengers

⚠WARNING

Severe internal injuries can occur if water is forced into body cavities as a result of being near the jet thrust nozzle. Do not apply throttle until each passenger is seated with his or her feet on the floor of the footwell and is holding on to the person in front of him or her.

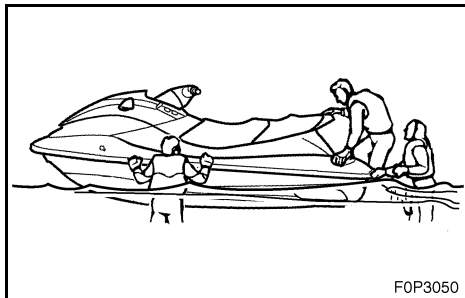

F0P3050

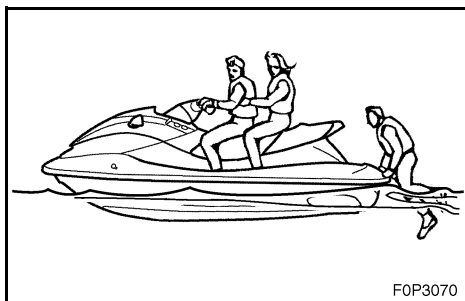

F0P3070

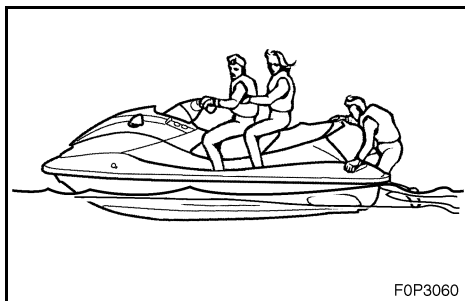

F0P3060

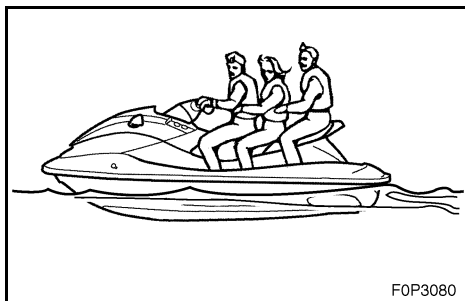

F0P3080

1. Climb on board as noted in the previous section, and sit astride the seat. Attach the engine shut-off cord to your left wrist, and then install the clip to the engine shut-off switch.
2. Have the passenger move to the rear of the watercraft.
3. Have the passenger get on board and sit on the seat. If a second passenger is getting on, have him or her follow the same procedure.

NOTE:

When a passenger is getting on board, both he and the operator should try to balance the watercraft.

4. The operator should check to see that the passengers have their feet on the floor of the footwell and that they are securely holding on to the person in front of them.
5. Start the engine, look in all directions, and then accelerate to planing speed.

⚠WARNING

Before starting off, make sure that there are no boats, obstructions, or swimmers around you.

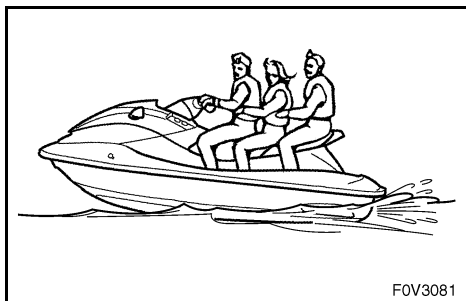
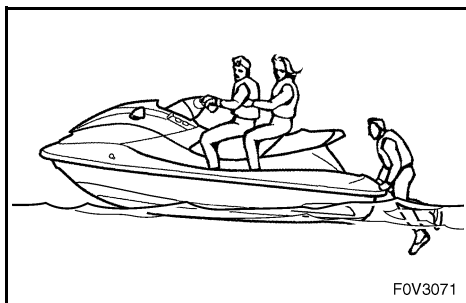
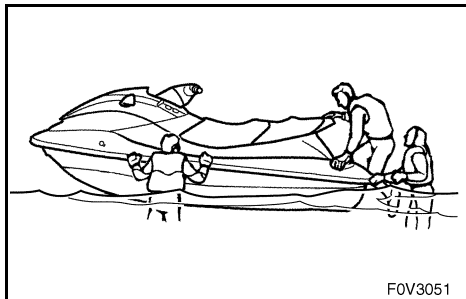
**NOTE:**

The heavier the total weight of the operator and passengers, the more difficult it will be to balance the watercraft. Do not operate the watercraft when the total weight exceeds 240 kg (530 lb) including any cargo. If it is difficult to balance the watercraft at a standstill, proceed as follows:

1. The passenger must steady the watercraft while the operator is boarding. The operator pulls him or herself up to a kneeling position on the platform, and then moves to the seat and sits astride to balance the watercraft.
2. The operator attaches the engine shut-off cord to his or her left wrist, and then installs the clip to the engine shut-off switch.
3. The operator starts the engine and lets it run at idle.
4. The passenger pulls him or herself up to a kneeling position, and then crawls onto the seat as the watercraft accelerates.
5. The operator gradually increases speed to balance the watercraft.



EJU18831

Capsized watercraft

If the watercraft capsizes, turn it over immediately.

Be sure to carefully follow the procedures below to prevent injury or damage to the watercraft.

⚠ WARNING

IMPROPER UPRIGHTING CAN CAUSE INJURY:

- Shut the engine off by pulling on the engine shut-off cord to remove the clip from the engine shut-off switch.
- Do not put your hands in the intake grate.
- Watch so you are not hit by the watercraft as it comes over.

CAUTION:

Be sure to remove the clip from the engine shut-off switch to shut the engine off, otherwise the engine can overheat, which can result in severe engine damage.

1. Shut the engine off by removing the clip from the engine shut-off switch.
2. Swim to the rear of the watercraft. Pull the watercraft over with your left hand on the ride plate while pushing down on the gunwale with your right hand or foot.

NOTE:

If the port (left) side of the capsized watercraft is tilting up, push down on the gunwale so that the port (left) side is down before turning the watercraft clockwise.

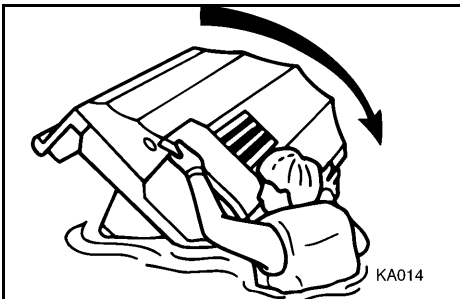
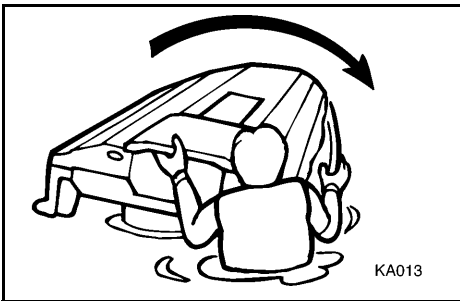

**CAUTION:**

Do not turn the watercraft over counter-clockwise, otherwise water can leak into the carburetor and engine, which can result in severe damage.

3. Start the engine and operate the watercraft to discharge any water remaining in the engine compartment. (If the engine does not start, see page 5-7, "Towing the watercraft" or page 5-8, "Submerged watercraft.")

NOTE:

To efficiently discharge water from the engine compartment, operate the watercraft as straight as possible and above planing speed for at least 2 minutes.



EJU01839

Turning the watercraft

Steering control depends on the combination of handlebar position and the amount of throttle.

Water sucked in through the intake grate is pressurized by the impeller in the jet pump. As the pressurized water is expelled from the pump through the jet thrust nozzle, it creates thrust to move and steer the watercraft. The higher the engine speed, the more thrust is produced.

The amount of jet thrust, in addition to the position of the handlebars, determines how sharply you turn.

- A. More throttle produces higher thrust, so the watercraft will turn more sharply.
- B. Less throttle produces lower thrust, so the watercraft will turn more gradually.
- C. Releasing the throttle completely produces only minimum thrust. If you are traveling at speeds above trolling, you will have rapidly decreasing ability to steer without throttle. You may still have some turning ability immediately after releasing the throttle, but once the engine slows down, the watercraft will no longer respond to handlebar input until you apply throttle again or you reach trolling speed.

At trolling speed, the watercraft can be turned gradually by handlebar position alone using just the amount of thrust available at idle.

- D. If the engine is stopped while riding, there is no thrust. The watercraft will go straight even though the handlebars are turned.

You need throttle to steer.

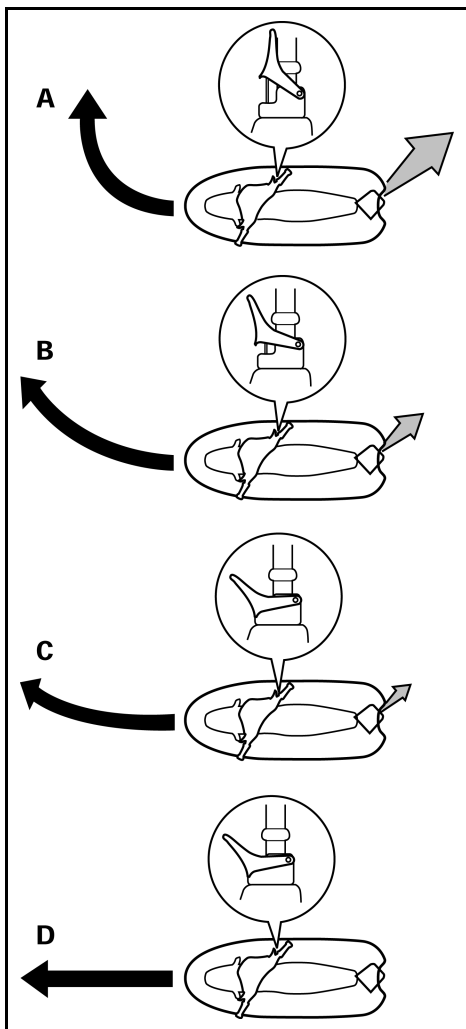
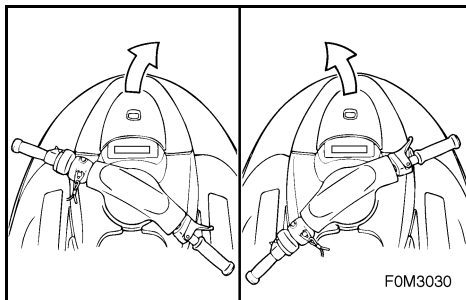

**⚠ WARNING**

- Do not release the throttle when trying to steer away from objects—you need throttle to steer. A collision could result in severe injury or death.
- When operating at higher speeds, make gradual turns or slow down before turning. Sharp high-speed turns may cause the watercraft to slide sideways or spin, throwing the operator and passengers overboard which could cause an injury.



EJU01080

Stopping the watercraft

The watercraft is not equipped with a separate braking system. It is stopped by water resistance when the throttle lever is released. From full speed, the watercraft comes to a complete stop in approximately 95 m (310 ft) after the throttle is released and the engine is stopped, although this distance will vary depending on many factors, including gross weight, water surface conditions, and wind direction. The watercraft slows down as soon as the throttle lever is released, but will coast for a distance before fully stopping. If you are not sure you can stop in time before hitting an obstacle, apply throttle and turn in another direction.

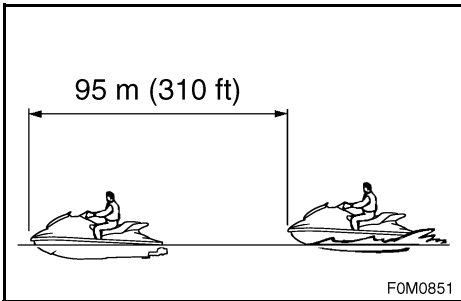

⚠ WARNING

- **Allow adequate stopping distance.**
- **Take early action to avoid collisions. Remember, watercraft and other boats do not have brakes.**
- **Operate defensively at safe speeds and keep a safe distance away from people, objects, and other watercraft to give you time to stop.**
- **Do not shut the engine off when slowing down in case you need engine power to steer away from a boat or other obstacle that comes into your path.**



EJU01081

Beaching the watercraft

1. Make sure no obstructions, boats or swimmers are near the beach. Release the throttle lever about 95 m (310 ft) before you reach the intended beaching area.
2. Approach the beach slowly and stop the engine before reaching land.
Remember: you need throttle to steer.
3. Get off the watercraft and pull it up on the beach.

CAUTION:

Small pebbles, sand, seaweed, and other debris can be pulled into the jet intake and impair or damage the impeller. Always stop the engine and get off before beaching the watercraft.

EJU01082

Docking the watercraft

1. Make sure that no obstructions, boats or swimmers are close to the watercraft. Reduce speed about 95 m (310 ft) away from the dock.
2. Slowly approach the dock and stop the engine just before coming alongside it.



EJU01255

Rough water operation

The force of landing after jumping can cause a strong impact on both the watercraft and the operator and passengers. It is possible for the operator to hit his or her chest or jaw on the watercraft body or handlebars and be injured. Do not operate the watercraft with your chin right above the handlebars or with your feet outside the watercraft. Operating in rough water or jumping waves can also crack the watercraft body or damage internal parts. Avoid operating in rough water or bad weather conditions.



EJU01084

Post-operation checks

Always perform the following post-operation checks after operating the watercraft.

1. Remove the watercraft from the water.
2. Wash down the hull, handlebars, and jet unit with fresh water.
3. Remove the seat and check the engine compartment for water. To drain excess water, remove the stern drain plugs, then raise the bow of the watercraft enough to allow water in the bilge to drain out.

NOTE: _____

This watercraft is equipped with an automatic bilge-draining system that removes water from the engine compartment while you are underway. However, some residual water will remain.

4. Put the watercraft in a horizontal position.
5. Flush the cooling system to prevent it from clogging with salt, sand, or dirt. (See page 4-1 for flushing the cooling system procedures.)
6. Drain residual water from the exhaust system by alternately squeezing and releasing the throttle lever for 10 to 15 seconds while the engine is running.

CAUTION: _____

Do not attempt to run the engine at full throttle or for more than 15 seconds while the watercraft is out of the water, otherwise the engine may overheat or seize.

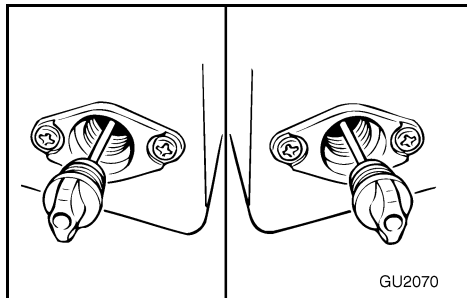



7. If the watercraft will be stored for a week or more, lubricate internal engine components to help prevent corrosion. (See page 4-3 for lubrication procedures.)
8. Rinse the engine and engine compartment with a small amount of water.

CAUTION:

Do not use high pressure when rinsing the engine or engine compartment as severe engine damage could result.

9. Wipe the engine and engine compartment dry with a clean cloth (repeat step 3, if necessary).
10. Wipe the hull, handlebars, and jet unit dry with a clean cloth.
11. Spray a rust inhibitor on metallic parts to minimize corrosion.
12. Allow the engine compartment to air dry completely before reinstalling the seat.



EJU01085

Transporting

⚠ WARNING

Always place the fuel cock knob in the “OFF” position when transporting the watercraft, otherwise fuel could leak out into the engine or engine compartment, which would create a fire hazard.

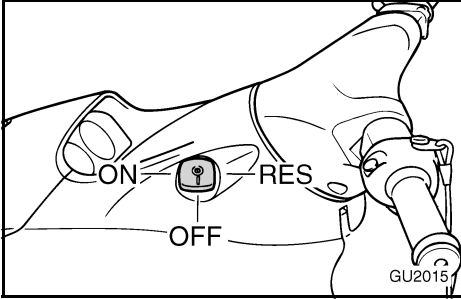

When transporting the watercraft on a trailer, secure the tie downs to the trailer through the bow eye and stern rope holes.

CAUTION:

Do not route ropes or tie downs over the seat, as they may leave permanent marks on the seat's surface. Also, wrap the ropes or tie downs with towels or rags where they touch the body of the watercraft to avoid scratching or damage.

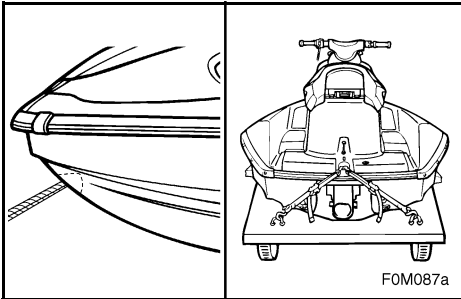



-MEMO-

EJU01086

MAINTENANCE AND CARE



Storage	4-1
Flushing the cooling system	4-1
Lubrication	4-3
Fuel system	4-4
Battery	4-5
Cleaning the watercraft	4-6
Maintenance and adjustments	4-7
Owner's/Operator's Manual and tool kit	4-8
Periodic maintenance chart	4-9
Inspecting the fuel system	4-10
Inspecting the oil injection system	4-12
Inspecting the jet thrust nozzle angle	4-13
Inspecting and adjusting the throttle cable	4-13
Cleaning and adjusting the spark plugs	4-14
Lubrication points	4-15
Adjusting the choke cable	4-17
Inspecting the battery	4-18
Adjusting the carburetor	4-20
Replacing the fuse	4-21
Bleeding the oil injection pump	4-21
Specifications	4-22

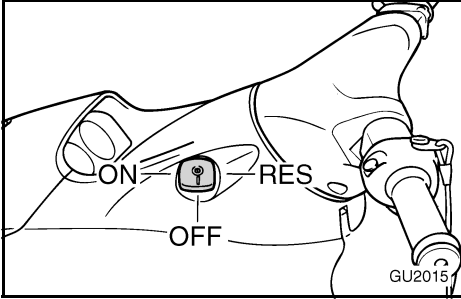

EJU01087

Storage

⚠ WARNING

Always place the fuel cock knob in the “OFF” position when storing the watercraft, otherwise fuel could leak out into the engine or engine compartment, which would create a fire hazard.

Storage for prolonged periods of time, such as winter storage, requires preventative maintenance to ensure against deterioration. It is advisable to have the watercraft serviced by a Yamaha dealer prior to storage. However, the following procedures can be performed by the owner.

EJU01088

Flushing the cooling system

Flushing the cooling system is essential to prevent the cooling system from being clogged with salt, sand, or dirt.

CAUTION:

- Do not supply water to the cooling water passages when the engine is not running. The water could flow back through the muffler into the crankcase causing severe engine damage.
- Do not run the engine for more 15 seconds without supplying water, otherwise the engine may overheat.

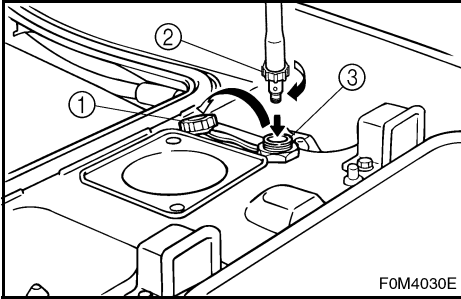

1. Put the watercraft on land in a horizontal position.
2. Open the flushing hose connector cap ①, and then insert the garden hose adapter ② into the flushing hose connector ③ and turn it until it is securely connected.
3. Connect the garden hose adapter to a water tap using a hose.
4. Start the engine, and then immediately turn the water supply on until water flows out continually from the cooling water pilot outlet.
5. Run the engine at idling speed for about 3 minutes watching the engine condition. If the engine stops while flushing, turn the water supply off immediately and repeat the above steps.
6. Turn the water supply off, and then force the remaining water out from the cooling passages by alternately squeezing, and releasing the throttle lever for 10 to 15 seconds.
7. Stop the engine.
8. Remove the garden hose adapter and secure the cap.



EJU01299

Lubrication

⚠ WARNING

To reduce the risk of fire or explosion:
Never pour or spray gasoline, or any substance other than a rust inhibitor through the hole in the carburetor silencer cover.

CAUTION:

- Make sure to replace the cap securely after fogging the engine, otherwise water could enter the engine and cause damage.
- Do not attempt to run the engine at full throttle or for more than 15 seconds while the watercraft is out of the water, otherwise the engine may overheat and/or seize.

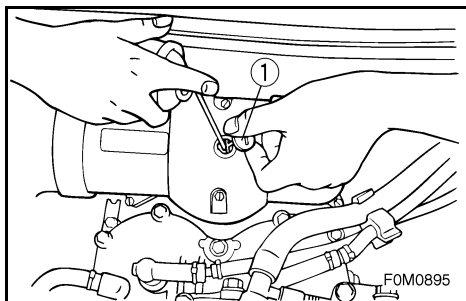

1. Open the silencer cap ① on the silencer.
2. Start the engine with the watercraft in a well-ventilated area.
3. With the engine running at a fast idle, quickly spray as much rust inhibitor as possible through the hole in the silencer cover. Keep spraying until the engine stalls (or a maximum of 15 seconds).
4. Install the cap securely.
5. Lubricate all cables such as the throttle, choke, and steering cables.

NOTE:

Use a suitable marine grease applicator to pressure lubricate the cables and purge out any moisture between the inner and outer cables.

6. Lubricate the areas of the watercraft specified under Lubrication points on page 4-15.



EJU01964

Fuel system

Draining the fuel system prevents buildup of varnishes and other harmful deposits that result when gasoline sits for a prolonged period of time.

⚠ WARNING

GASOLINE AND ITS VAPORS ARE HIGHLY FLAMMABLE AND EXPLOSIVE!

- Do not smoke when refueling, and keep away from sparks, flames, or other sources of ignition.
- Stop engine before refueling.
- Refuel in a well-ventilated area with the watercraft in a horizontal position.
- Do not stand or sit on the watercraft while refueling in case of fire.
- Take care not to spill gasoline. If gasoline spills, wipe it up immediately with dry rags. Always properly dispose of gasoline-soaked rags.
- Avoid overfilling the fuel tank. Stop filling when the fuel level just reaches the bottom of the filler tube. Do not fill up the filler tube because fuel expands as it warms up and could overflow. If temporarily leaving the watercraft with a full fuel tank, do not leave it in direct sunlight. Leave it in a well-ventilated area with the watercraft in a horizontal position.
- Tighten the filler cap securely after refueling.
- If you should swallow some gasoline, inhale a lot of gasoline vapor, or get gasoline in your eyes, get immediate medical attention.
- If any gasoline spills onto your skin, immediately wash with soap and water. Change clothing if gasoline spills on it.



To drain the fuel system:

1. Place the fuel cock knob in the “OFF” position.
2. Drain the fuel tank using a siphon.

EJU01970

Battery

If the watercraft will not be used for more than a month, disconnect the negative (–) lead first, then the positive (+) lead and breather hose, and then remove the battery from the watercraft.

Clean the battery casing using fresh water.

If the battery terminals are dirty or corroded, clean them with a wire brush.

Fully charge the battery, and then store it in a cool, dark place.

Apply Yamaha marine grease or Yamaha grease A to the battery terminals.

Check the battery at least every 2 months and fully charge it if necessary.

⚠WARNING

Be sure to connect the breather hose to the battery. Fire or explosion could result if the breather hose is damaged, obstructed, or not connected properly.

CAUTION:

The battery may not be usable again if you store it for a long period without charging it. Charge the battery periodically.

**NOTE:** _____

The condition of the battery can be known by checking the specific gravity of the electrolyte. However, you can also know the condition of the battery by measuring the voltage at both battery terminals. Charge the battery if the voltage is less than 12 volts.

Specific gravity (for reference): 1.28 at 20 °C (68 °F)
--

It is recommended to have a Yamaha dealer check the specific gravity and to charge the battery. If you maintain the battery yourself, be sure to read and follow the instructions provided with the battery tester and charger you use.

EJU01093

Cleaning the watercraft

Clean the watercraft before storing it for a long period.

1. Wash down the hull, handlebars, and drive unit with fresh water.
2. Rinse the engine and bilge area with fresh water. Drain off all water and wipe up remaining moisture with clean, dry rags.
3. Spray the engine's exterior with a rust inhibitor and lubricant.
4. Wax the hull with a non-abrasive wax.
5. Wipe all vinyl and rubber components, such as the seat and engine compartment seals, with a vinyl protectant.



Maintenance and adjustments

Periodic inspection, adjustment and lubrication will keep your watercraft in the safest and most efficient condition possible. Safety is an obligation of the watercraft owner. The most important points of watercraft inspection, adjustment and lubrication are explained on the following pages.

See your Yamaha dealer for genuine Yamaha replacement parts and optional accessories designed for your watercraft.

Remember that failures that are the result of the installation of parts or accessories which are not qualitatively equivalent to genuine Yamaha parts are not covered by the limited warranty.

⚠ WARNING

- **Be sure to turn off the engine when you perform maintenance unless otherwise specified, otherwise an accident or injury could result from unexpected operation, moving parts, or electric shock. If the owner is not familiar with watercraft servicing, this work should be done by a Yamaha dealer. Improperly serviced components could fail or stop operating correctly, which could result in an accident.**
- **Modifications to this watercraft not approved by Yamaha may cause loss of performance or excessive noise, or render it unsafe for use. Consult a Yamaha dealer before attempting any changes.**

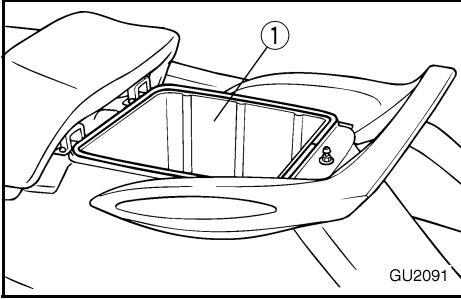

EJU01875

Owner's/Operator's Manual and tool kit

It is advisable always to carry the Owner's/Operator's Manual and tool kit (2) with you whenever you use the watercraft. For your convenience, a storage compartment (1) is provided on the watercraft for the manual and tool kit.

NOTE:

To protect these materials from water damage, it would be a good idea to put them in a waterproof bag.

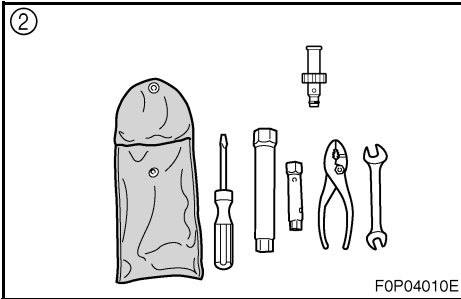

The service information included in this manual is intended to provide you with the necessary information for completing your own preventive maintenance and minor repairs. The tools provided in the tool kit are sufficient for this purpose.



EJU01355

Periodic maintenance chart

The following chart gives general guidelines for periodic maintenance. However, depending on your operating conditions maintenance may need to be performed more frequently.

- This mark indicates maintenance that you may do yourself.
- This mark indicates work to be done by a Yamaha dealer.

MAINTENANCE INTERVAL ITEM		INITIAL			THEREAFTER EVERY		PAGE
		10 hours	50 hours	100 hours	100 hours	200 hours	
			6 months	12 months	12 months	24 months	
Spark plug	Inspect, clean, adjust	●	●	●	●		4-14
Lubrication points	Lubricate			●	●		4-15
Intermediate housing	Lubricate	○*1		●*2	●*2		4-16
Fuel system	Inspect			○	○		4-10
Fuel filter	Check, clean, replace	○				○	4-11
Fuel tank	Inspect, clean					○	4-11
Oil injection system	Inspect, clean	○				○	—
Carburetor setting	Inspect, adjust	○		○	○		4-20
Trolling speed	Inspect, adjust			●	●		4-20
Carburetor throttle shaft	Inspect			○	○		—
Cooling water passages	Flush	●*3					4-1
Bilge strainer	Clean			●	●		—
Impeller	Inspect			○	○		—
Jet thrust nozzle angle	Inspect, adjust			●/○	●/○		4-13
Throttle cable	Inspect, adjust	○		○	○		4-13
Choke cable	Inspect, adjust			○	○		4-17
Stern drain plugs	Inspect, replace			○	○		3-8
Battery	Inspect			○	○		4-18
Rubber coupling	Inspect					○	—
Engine mount	Inspect					○	—
Nuts and bolts	Inspect	○		○	○		—

*1: Grease quantity: 33.0–35.0 cm³ (1.11–1.18 oz)

*2: Grease quantity: 6.0–8.0 cm³ (0.20–0.27 oz)

*3: After every use



EJU01383

Inspecting the fuel system

⚠WARNING

Gasoline is highly flammable and explosive. A fire or explosion can cause severe injury or death. Shut off the engine. Do not smoke. Avoid spilling gasoline.

Check the fuel system for leaks, cracks, or malfunctions. If any problem is found, do the necessary repair or replacement as required. If repair is necessary, consult a Yamaha dealer.

Check:

- Carburetor for leakage.
- Fuel pump for malfunction or leakage.
- Fuel tank for water or dirt.
- Fuel tank for damage, cracks or leakage.
- Fuel hose joint for leakage.
- Fuel hose for cracks or other damage.
- Fuel filter for leakage.
- Fuel cock for leakage.
- Air vent check valve for leakage.
- Fuel tank filler cap for damage.

⚠WARNING

Failure to check for and repair any fuel leakage may result in fire or explosion.

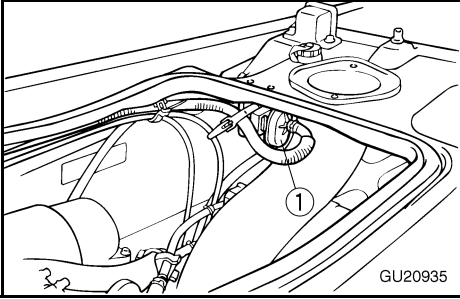

EJU01953

Fuel filter

This watercraft is equipped with a one-piece, disposable fuel filter ①. The fuel filter should be replaced after the initial 10 hours or first month of operation and every 200 hours or 24 months thereafter, or if water is found in the filter. Have a Yamaha dealer replace the fuel filter if necessary.

⚠WARNING

Do not try to replace the fuel filter yourself. An incorrectly installed filter can leak gasoline, which could lead to fire or explosion. If necessary, have a Yamaha dealer replace the fuel filter.

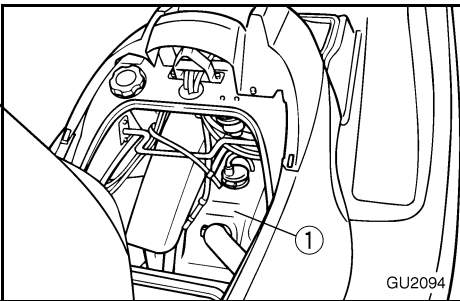

EJU01841

Fuel tank

Check the fuel tank ① for leakage or water in the tank. If water is found in the fuel system or if the fuel tank needs to be cleaned, have a Yamaha dealer service the watercraft.



EJU01100

Inspecting the oil injection system

Check the oil injection system for leakage, cracks, or malfunctions. If necessary, have a Yamaha dealer repair the oil injection system.

Check:

- Oil tank for damage, cracks or leakage.
- Oil tank for water or dirt.
- Oil hose and joint for damage or cracks.
- Oil filter for dirt.
- Oil pump for leakage.

EJU01101

Oil tank

Check the oil tank for leakage or water in the tank. If water is found in the oil injection system or if the oil tank needs to be cleaned have a Yamaha dealer service the watercraft.

EJU01102

Oil filter

Check the oil filter ① for dirt and clogs. If the oil filter is clogged, remove it from the oil tank together with the oil level sender and clean it.

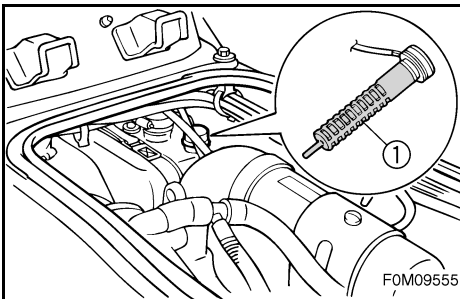

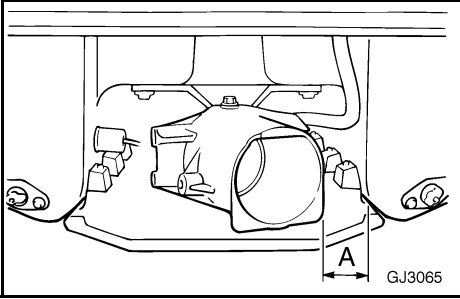

EJU01891

Inspecting the jet thrust nozzle angle

Check for smooth operation of the handlebars and jet thrust nozzle.

Turn the handlebars as far as possible to the right and left and check that the distance between the jet thrust nozzle and the hull are equal on right and left sides.

Distance A and B: $A=B$

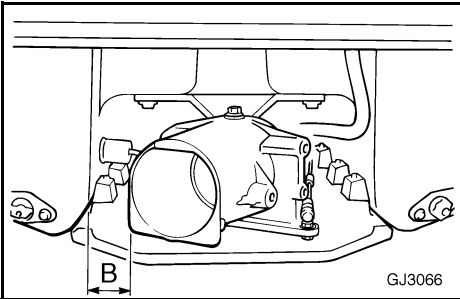

If steering is stiff or misadjusted, have a Yamaha dealer service it.

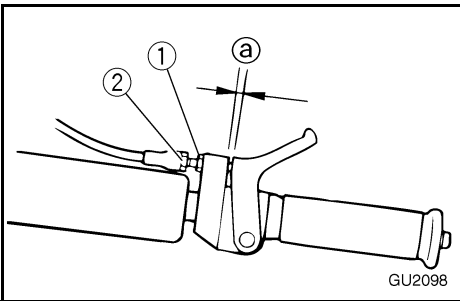

EJU01104

Inspecting and adjusting the throttle cable

Check that the throttle cable moves back to the set position smoothly and that free play is within specification.

1. Squeeze and release the throttle lever. If the lever does not return smoothly, have a Yamaha dealer service it.
2. Adjust free play \textcircled{a} by loosening the locknut $\textcircled{1}$ and turning the adjuster $\textcircled{2}$.

Throttle lever free play:
4–7 mm (0.16–0.28 in)



EJU01342

Cleaning and adjusting the spark plugs

The spark plug is an important engine component and is easy to inspect. The condition of the spark plug can indicate something about the condition of the engine. For example, if the center electrode porcelain is very white, this could indicate an intake air leak or carburetion problem in that cylinder. Do not attempt to diagnose any problems yourself. Have a Yamaha dealer service the watercraft.

Remove and inspect the spark plug periodically; heat and deposits will cause the spark plug to slowly break down and erode. If electrode erosion becomes excessive, or if carbon and other deposits are excessive, replace the spark plug with the specified plug.

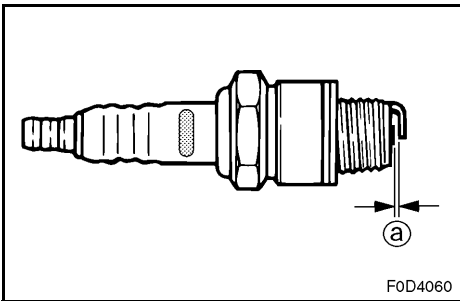

Standard spark plug: BR8HS

Measure the spark plug gap \textcircled{a} with a wire thickness gauge before installing the spark plug. Adjust the gap to specification if necessary.

Spark plug gap:
0.6–0.7 mm (0.024–0.028 in)

To reinstall spark plug:

1. Clean the gasket surface.
2. Wipe any dirt from the threads of the spark plug.
3. Screw the spark plug to the correct torque.

Spark plug torque:
25 N·m (2.5 kgf·m, 18 ft·lb)

**NOTE:**

- Wipe off any water on the spark plug or inside the cap before installing the spark plug cap. Push the spark plug cap down until it clicks.
- If a torque wrench is not available when you are fitting a new spark plug, a good estimate of the correct torque is 1/4 turn to 1/2 turn past finger tight. Have the spark plug adjusted to the correct torque with a torque wrench as soon as possible.

⚠WARNING

Be careful not to damage the insulator when removing or installing a spark plug. A damaged insulator could allow sparks to escape, which could lead to explosion or fire.

EJU11391

Lubrication points

To keep moving parts sliding or rotating smoothly, coat them with water-resistant grease.

Recommended water-resistant grease:
Yamaha Marine Grease/
Yamaha Grease A

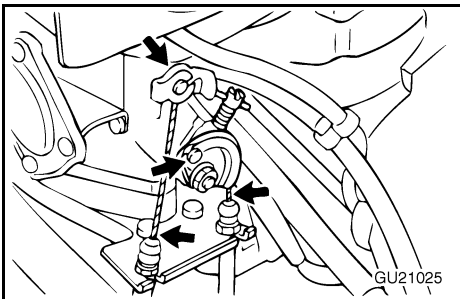

- Throttle cable (carburetor end)
- Choke cable (carburetor end)

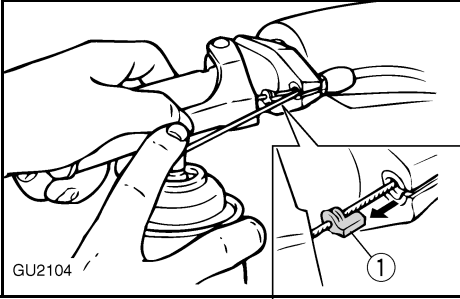

- Throttle cable (handlebar end)
Squeeze the throttle lever and remove the seal ①. Spray a rust inhibitor into the outer cable. Refit the seal securely.

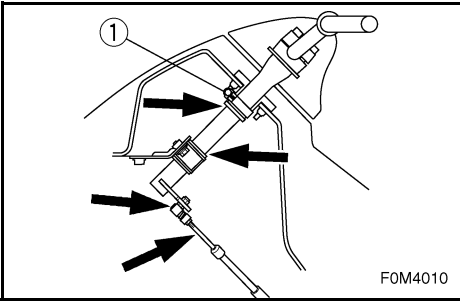

- Steering cable (handlebar end)
- Steering handle pivot shaft
If the steering pivot shaft becomes loose, tighten the band ① until a satisfactory feel is obtained.

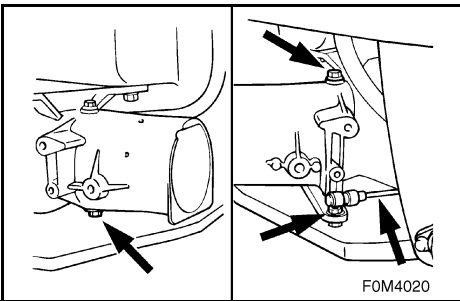

- Steering cable (nozzle end)
- Nozzle pivot shaft

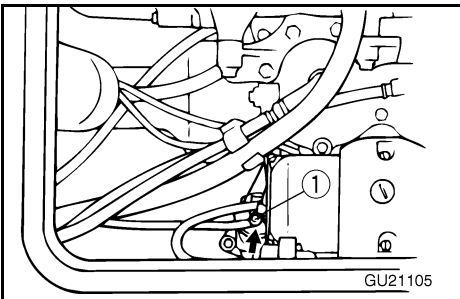

- Intermediate housing
Using a grease gun, fill the intermediate housing with water resistant grease through the grease nipple ①.

Grease quantity:

Initial 10 hours or 1 month:

33.0–35.0 cm³ (1.11–1.18 oz)

Every 100 hours or 12 months:

6.0–8.0 cm³ (0.20–0.27 oz)

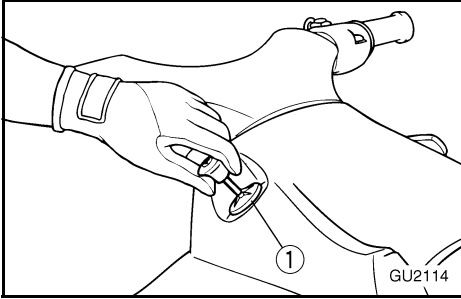

EJU01261

Adjusting the choke cable

Check that the choke cable is properly adjusted.

1. Pull the choke knob out until it stops, and then release the knob. The knob should not move.
2. If the choke knob moves back on its own, tighten the choke knob adjusting nut ① slightly. If the knob is difficult to move, loosen the adjusting nut slightly.



EJU01971

Inspecting the battery

Check the level of the battery electrolyte and make sure that the negative and positive leads are securely tightened.

⚠ WARNING

- **Battery electrolyte is poisonous and dangerous, causing severe burns, etc. Electrolyte contains sulfuric acid. Avoid contact with skin, eyes, or clothing.**

Antidotes

External: Flush with water.

Internal: Drink large quantities of water or milk. Follow with milk of magnesia, beaten egg, or vegetable oil. Call physician immediately.

Eyes: Flush with water for 15 minutes and get prompt medical attention.

Batteries produce explosive gases. Keep sparks, flame, cigarettes, etc., well away. If using or charging the battery in an enclosed space, make sure that it is well ventilated. Always shield your eyes when working near batteries.

KEEP OUT OF THE REACH OF CHILDREN.

- **Be sure to connect the breather hose to the battery. Fire or explosion could result if the breather hose is damaged, obstructed, or not connected properly.**

CAUTION:

- **Be careful not to place the battery on its side.**
- **Be sure to remove the battery from the battery compartment when adding electrolyte or charging the battery.**

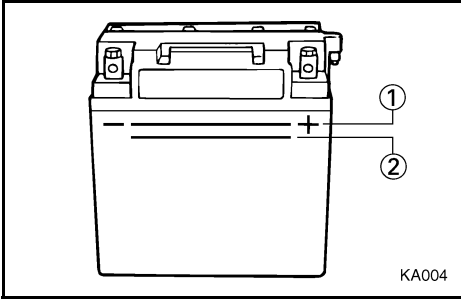
**To replenish the battery:**

1. Make sure that the electrolyte level is between the upper ① and lower ② level marks.
2. Refill the battery with distilled water if necessary.

CAUTION:

Normal tap water contains minerals that are harmful to a battery. Use only distilled water for replenishing the battery.

To recharge the battery:**CAUTION:**

Do not attempt to charge a battery hastily. Battery life could be shortened.

It is recommended to have a Yamaha dealer charge the battery. If you charge the battery yourself, carefully read the battery charger instructions before charging and follow the points below.

1. Remove all caps from the battery cell.
2. Add distilled water to the specified level if the electrolyte level is low.
3. Set the charging rate to 1.9 ampere and charge the battery slowly until the explosive gases are discharged vigorously from the battery cells.

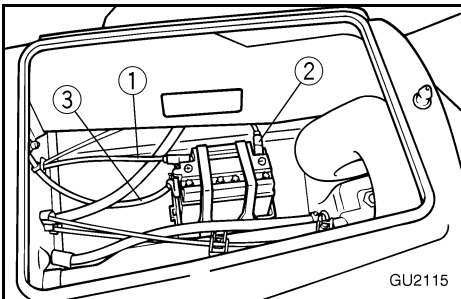
**To connect the battery terminals:**

1. Make sure that the connections are correct when you install the battery in the watercraft.
2. Make sure that the breather hose is properly connected and that it is not damaged or obstructed.
3. Make sure that the battery is securely held in place.

- ① Positive (+): Red lead
- ② Negative (-): Black lead
- ③ Breather hose



EJU01109

Adjusting the carburetor

The carburetor is a vital part of the engine and requires very sophisticated adjustment. Most adjusting should be left to a Yamaha dealer who has the professional knowledge and experience to perform it. However, the operator may adjust the trolling speed as part of the usual maintenance routine.

CAUTION:

The carburetor was set at the Yamaha factory after many tests. If the settings are disturbed by someone who does not have the necessary technical knowledge, poor engine performance and damage may result.

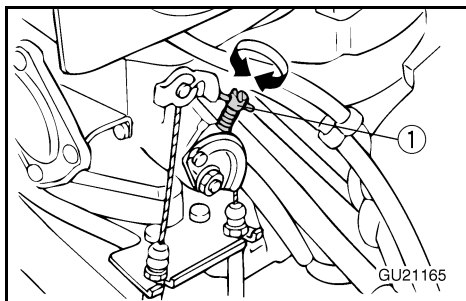

EJU01303

Adjusting the trolling speed

1. Put the watercraft in the water.
2. Start the engine and warm it up for 1 or 2 minutes. Using a diagnostic tachometer, adjust the engine speed to specification.
3. Turn the throttle stop screw ① clockwise to increase engine speed if necessary. Turn it counterclockwise to decrease engine speed if necessary.

Trolling speed: 1,250–1,350 r/min

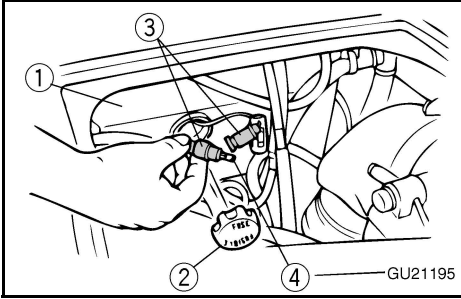

EJU01263

Replacing the fuse

The fuse is in the electrical box ①.

To replace the fuse:

1. Remove the cap ②, pull out the red lead, and bring the fuse holder ③ out of the electrical box.
2. Open the fuse holder and replace the fuse ④ with one of the correct amperage.

Fuse amperage: 10 A

⚠WARNING

Do not use fuses of higher amperage than those recommended. Substitution of a fuse of improper rating can cause extensive electrical system damage and possible fire.

EJU01112

Bleeding the oil injection pump

If the oil tank becomes completely empty, or any hose connected to the oil pump has been disconnected, the oil pump must be bled to ensure proper oil flow.

If bleeding of the oil pump is necessary, have a Yamaha dealer bleed it.



EJU01359

Specifications

ITEM	MODEL	Unit	XL700
WATERCRAFT CAPACITY			
Maximum people on board		Number of people	3
Maximum load capacity		kg (lb)	240 (530)
DIMENSIONS			
Length		mm (in)	3,150 (124)
Width		mm (in)	1,250 (49)
Height		mm (in)	1,100 (43)
Dry weight		kg (lb)	245 (540)
PERFORMANCE			
Maximum output		kW (PS) @ r/min	58.8 (80)@6,250
Maximum fuel consumption		L/h (US gal/h, Imp gal/h)	34.0 (9.0, 7.5)
Cruising range at full throttle		hr.	1.5
Trolling speed		r/min	1,250–1,350
ENGINE			
Engine type			2-stroke
Number of cylinders			2
Engine displacement		cm ³ (cu in)	701 (42.78)
Bore & stroke		mm (in)	81.0 × 68.0 (3.19 × 2.68)
Compression ratio			7.2:1
Lubrication system			Oil injection
Cooling system			Water-cooled
Starting system			Electric starter
Ignition system			C.D.I.
Spark plug			BR8HS (NGK)
Spark plug gap		mm (in)	0.6–0.7 (0.024–0.028)
Battery capacity		V-AH	12-19
Charging system			Flywheel magneto
DRIVE UNIT			
Propulsion system			Jet pump
Jet pump type			Axial flow, single stage
Impeller rotation			Counterclockwise (Viewed from rear)
Transmission			Direct drive from engine
Jet thrust nozzle angle		Degree	24 + 24
FUEL AND OIL			
Recommended fuel			Regular unleaded gasoline
Minimum octane rating		PON RON	86 90
Recommended engine oil			YAMALUBE 2-W, or an equivalent NMMA-certified TC-W3 marine oil
Fuel tank capacity			
Total		L (US gal, Imp gal)	50 (13.2, 11)
Reserve		L (US gal, Imp gal)	12 (3.2, 2.6)
Oil tank capacity		L (US gal, Imp gal)	3.8 (1.0, 0.8)



-MEMO-

EJU01115

TROUBLESHOOTING AND EMERGENCY PROCEDURES

Troubleshooting	5-1
Troubleshooting chart	5-1
Emergency procedures	5-4
Cleaning the jet intake and impeller	5-4
Jumping the battery	5-5
Towing the watercraft	5-7
Submerged watercraft	5-8





EJU01116

Troubleshooting

If you have any trouble with your watercraft, use this section to check for the possible cause.

If you cannot find the cause, or if the procedure for replacement or repair is not described in this Owner's/Operator's Manual, have a Yamaha dealer perform the necessary service.

EJU01367

Troubleshooting chart

TROUBLE	POSSIBLE CAUSE		REMEDY	PAGE
Engine does not start	Starter motor does not turn over			
	Engine shut-off switch	Clip not in place	Install clip	2-9
	Fuse	Burned out	Replace the fuse and check wiring	4-21
	Battery	Run down	Recharge	4-18
		Poor terminal connections	Tighten as required	4-18
		Terminal corroded	Clean	4-5
	Starter motor	Faulty	Have serviced by Yamaha dealer	—
	Starter motor turns over			
	Fuel cock	Turned to "OFF"	Turn the fuel cock to "ON"	2-8
	Fuel	Empty	Refill as soon as possible	3-3
		Stale or contaminated	Have serviced by Yamaha dealer	4-10
	Fuel tank	Water or dirt present	Have serviced by Yamaha dealer	4-11
	Spark plug	Fouled or defective	Clean or replace	4-14
	Spark plug cap	Not connected or loose	Connect properly	4-14
	Crankcase	Filled with water	Crank engine with plug out until clean	5-8
Fuel filter	Clogged or water pooled	Have serviced by Yamaha dealer	4-11	
Choke	Knob moves back on its own	Tighten the choke knob adjusting nut	4-17	



TROUBLE	POSSIBLE CAUSE		REMEDY	PAGE
Engine runs irregularly or stalls	Fuel	Empty	Refill as soon as possible	3-3
		Stale or contaminated	Have serviced by Yamaha dealer	4-10
	Choke	Knob pulled	Push fully in	2-9
	Fuel filter	Clogged or water pooled	Have serviced by Yamaha dealer	4-11
	Fuel tank	Water or dirt present	Have serviced by Yamaha dealer	4-11
	Spark plug	Fouled or defective	Replace	4-14
		Incorrect heat range	Replace	4-14
		Gap incorrect	Adjust	4-14
	Spark plug cap	Loose	Connect properly	4-14
		Cracked, torn, or damaged	Replace	—
	Electrical wiring	Loose connection	Tighten or connect properly	—
	Carburetor	Incorrect idle adjustment	Adjust idle	4-20
Clogged		Have serviced by Yamaha dealer	—	
Warning light blinks	Engine oil level	Empty	Refill immediately	3-4
		Oil filter clogged	Clean	4-12



TROUBLE	POSSIBLE CAUSE		REMEDY	PAGE
Watercraft slow or loses power	Cavitation	Jet intake clogged	Clean	5-4
		Impeller damaged or worn	Have serviced by Yamaha dealer	—
	Engine over-heated	Jet intake clogged	Clean	5-4
	Fuel filter	Clogged	Have serviced by Yamaha dealer	4-11
	Spark plug	Fouled or defective	Replace	4-14
		Incorrect heat range	Replace	4-14
		Gap incorrect	Adjust	4-14
	Spark plug caps	Loose	Connect properly	4-14
	Electrical wiring	Loose connection	Tighten or connect properly	—
	Fuel	Stale or contaminated	Have serviced by Yamaha dealer	4-10
Bilge	Water in bilge	Drain	3-8	

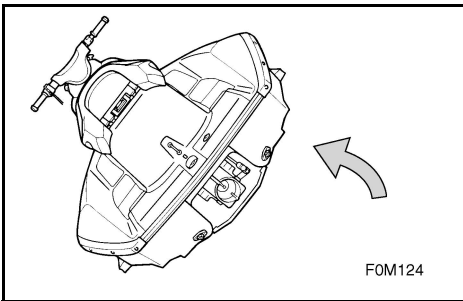
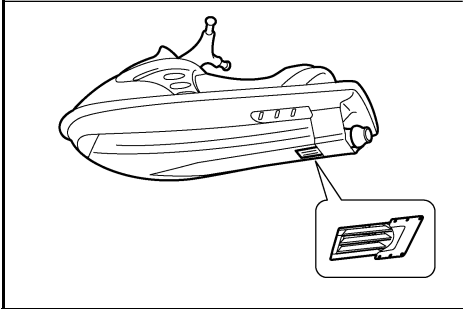
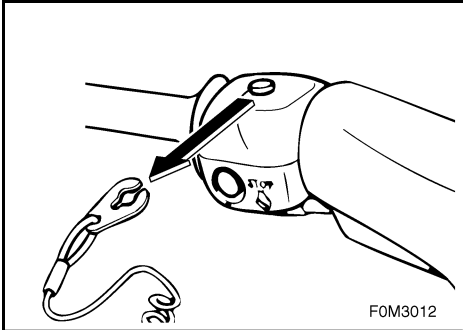

EJU01118

Emergency procedures

EJU01119

Cleaning the jet intake and impeller

If weeds or debris get caught in the intake or impeller, cavitation can occur, causing jet thrust to decrease even though engine speed rises. If this condition is allowed to continue, the engine will overheat and may seize. If there is any sign that the jet intake or impeller is clogged with weeds or debris, beach the watercraft and check the intake and impeller. Always stop the engine before beaching the watercraft.

⚠WARNING

Before attempting to remove weeds or debris from the jet intake or impeller areas, shut the engine off and remove the clip from the engine shut-off switch. Severe injury or death could result from contact with the rotating parts of the jet pump.

1. Turn the watercraft on its side as shown.

CAUTION:

- Place a suitable clean cloth or carpeting underneath the watercraft to protect it from abrasions and scratches.
- Always turn the watercraft over onto its port (left) side.
- When turning the watercraft on its side, support the bow so the handlebars cannot be bent or damaged.



2. Remove any weeds or debris from around the drive shaft, impeller, pump housing, and jet thrust nozzle.
If debris is difficult to remove, consult your Yamaha dealer.

CAUTION:

Always avoid operating your watercraft in areas where weed growth is thick. If traveling in weeded areas is unavoidable, operate the engine alternately at partial throttle and full throttle. Weeds tend to accumulate more at a steady speed and at trolling speed. If weeds clog the intake or impeller area and cause cavitation, follow the cleaning procedure above.

EJU01844

Jumping the battery

If the watercraft battery has run down, the engine can be started using a 12-volt battery and jumper cables.

⚠WARNING

Battery electrolyte is poisonous and dangerous, causing severe burns, etc. Electrolyte contains sulfuric acid. Avoid contact with skin, eyes or clothing.

Antidotes

External: Flush with water.

Internal: Drink large quantities of water or milk. Follow with milk of magnesia, beaten egg or vegetable oil. Call physician immediately.

Eyes: Flush with water for 15 minutes and get prompt medical attention.

Batteries produce explosive gases. Keep sparks, flame, cigarettes, etc. well away. If using or charging the battery in an enclosed space, make sure that it is well ventilated. Always shield your eyes when working near batteries.

KEEP OUT OF THE REACH OF CHILDREN.

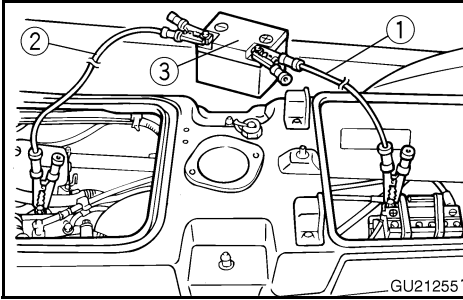

EJU01882

Connecting the jumper cables

1. Connect the positive (+) jumper cable ① to the positive (+) terminals of both batteries.
2. Connect one end of the negative (-) jumper cable ② to the negative (-) terminal of the booster battery ③.
3. Connect the other end of the negative (-) cable to an unpainted bolt on the cylinder head.

CAUTION: _____

Do not connect the end of the jumper cable to the negative (-) terminal on the watercraft battery! Be sure all connections are secure and correct before attempting to start the engine. Any wrong connection may damage the electrical system.

4. Start the engine, and then disconnect the cables by reversing the steps above.

CAUTION: _____

- Never push the start switch while the engine is running.
- Do not operate the start switch for more than 5 seconds, otherwise the battery will be discharged and the engine will not start. Also, the starter motor may be damaged. If the engine does not start in 5 seconds, release the start switch, wait 15 seconds, and try again.



EJU01913

Towing the watercraft

If the watercraft becomes inoperative in the water, it can be towed to shore.

If the watercraft must be towed in an emergency using a towline, the operator should ride the watercraft, holding onto the handlebars.

CAUTION:

- Tow the watercraft at 5 mph (8 km/h) or less, otherwise water could enter the engine through the exhaust passages or through the air intake and flood the engine compartment if it is towed too fast.
- Tow the watercraft using the bow eye ① only.
- The bow must be kept up out of the water during towing to prevent water from entering the engine compartment.

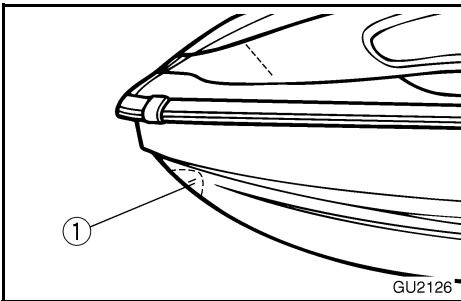

⚠WARNING

- The watercraft should only be towed in an emergency.
- The towline should be long enough so that the watercraft will not collide with the towing boat when slowing down. A good rule of thumb is a towline that is three times the combined length of the towing boat and the watercraft.
- The operator of the towing boat must keep speed to a minimum and avoid traffic or obstacles which could be a hazard to the rider on the watercraft.



EJU01905

Submerged watercraft

If the watercraft is submerged or flooded with water, follow the procedure below and consult a Yamaha dealer as soon as possible. Failure to do so may result in serious engine damage!

In an emergency:

1. Beach the watercraft and remove the stern drain plugs to drain the water from the engine compartment.
2. Turn the fuel cock knob to "OFF."
3. Remove the spark plugs and dry them with a cloth.
4. Without reinstalling the spark plugs, crank the engine until all the water in the cylinders has been drained.
5. Install the stern drain plugs and the spark plugs.
6. Turn the fuel cock to "ON."
7. Launch the watercraft into the water, and then run the engine for at least 10 minutes. If the engine does not start, repeat steps 2–7.
8. Turn the engine off.
9. Turn the fuel cock to "OFF," remove the silencer cap, and then spray a rust inhibitor into the carburetor while cranking the engine.
10. Have the watercraft inspected by a Yamaha dealer as soon as possible.



-MEMO-

EJU01124

APPENDIX

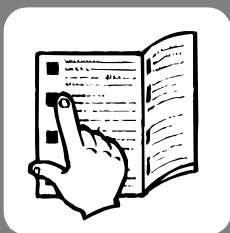

Index 6-1



Index

2-stroke engine oil 3-2

A

Adjusting the carburetor 4-20

Adjusting the choke cable 4-17

Adjusting the trolling speed 4-20

Approval label of Emission control
certificate 1-2

B

Battery 3-9, 4-5

Beaching the watercraft 3-32

Bilge 3-8

Bleeding the oil injection pump 4-21

Boarding alone 3-24

Boarding and starting in deep water 3-24

Boarding with passengers 3-25

C

Capsized watercraft 3-27

Choke knob 2-9

Cleaning and adjusting the spark
plugs 4-14

Cleaning the jet intake and impeller 5-4

Cleaning the watercraft 4-6

Connecting the jumper cables 5-6

Cooling water pilot outlet 2-11, 3-13

Cruising limitations 1-10

D

Docking the watercraft 3-32

E

Emergency procedures 5-4

Emission control information
(For Canada only) 1-2

Engine break-in 3-14

Engine compartment 3-6

Engine overheat warning system 2-13

Engine serial number 1-1

Engine shut-off cord (lanyard) 3-12

Engine shut-off switch 2-9

Engine stop switch 2-9

Enjoy your watercraft responsibly 1-17

F

Filling the fuel tank 3-3

Filling the oil tank 3-4

Finger grip 2-12

Fire extinguisher 3-10

Flushing the cooling system 4-1

Front seat 2-5

Front storage compartment 2-15

Fuel and oil 3-1

Fuel and oil systems 3-7

Fuel cock knob 2-8

Fuel filter 4-11

Fuel system 4-4

Fuel tank 4-11

Fuel tank filler cap 2-7

G

Gasohol 3-2

Gasoline 3-1

Getting to know your watercraft 3-20

Glove compartment 2-16

H

Handgrip 2-12

Hazard information 1-14

Hood 2-6

Hull and deck 3-6

Hull Identification Number (HIN) 1-1

I

Identification numbers 1-1

Important labels 1-3

Inspecting and adjusting the throttle
cable 4-13

Inspecting the battery 4-18

Inspecting the fuel system 4-10

Inspecting the jet thrust nozzle angle 4-13

Inspecting the oil injection system 4-12

J

Jet unit 3-12

Jumping the battery 5-5

L

Label location 1-3

Learning to operate your watercraft 3-20

Leaving the watercraft 3-19



Limitations on who may operate the watercraft	1-9	Starting the engine	3-16
Location of main components	2-1	Starting the watercraft	3-22
Lubrication.....	4-3	Start switch.....	2-10
Lubrication points	4-15	Steering system	2-11, 3-11
M		Stern drain plug	3-8
Maintenance and adjustments	4-7	Stopping the engine	3-19
Manufactured date label.....	1-2	Stopping the watercraft	3-31
O		Storage.....	4-1
Oil filter	4-12	Storage compartments	2-15
Oil level warning lamp	2-14	Submerged watercraft	5-8
Oil tank	4-12	Switches	3-13
Oil tank filler cap.....	2-7	T	
Operating your watercraft.....	3-20	Throttle	3-11
Operation	3-14	Throttle lever	2-10
Operation of controls and other functions	2-4	Towing the watercraft.....	5-7
Operation requirements	1-11	Transporting	3-36
Other labels.....	1-7	Troubleshooting	5-1
Owner's/Operator's Manual and tool kit.....	4-8	Troubleshooting chart	5-1
P		Turning the watercraft	3-29
Periodic maintenance chart.....	4-9	W	
Post-operation checks.....	3-34	Warning labels	1-4
Pre-operation check list.....	3-5	Watercraft characteristics.....	1-14
Pre-operation check points	3-6	Water separator	3-7
Pre-operation checks	3-5	Water-skiing	1-15
Primary Identification (PRI-ID) number	1-1		
R			
Rear seat.....	2-4		
Recommended equipment.....	1-13		
Replacing the fuse	4-21		
Riding watercraft with passengers	3-21		
Rough water operation.....	3-33		
S			
Safe boating rules	1-17		
Safety information	1-9		
Seat storage compartment.....	2-16		
Specifications	4-22		
Starting and boarding in shallow water	3-23		
Starting from a dock	3-23		



Printed in USA
Jun. 2003—0.7 × 1 CR
FOM-F8199-75
(E)

Printed on recycled paper