



 Read this manual carefully before operating this vehicle.

OWNER'S MANUAL

XSR900

MTM850

BAE-28199-E0

 **Read this manual carefully before operating this vehicle. This manual should stay with this vehicle if it is sold.**

Declaration of Conformity:

Hereby, YAMAHA MOTOR ELECTRONICS Co., Ltd declares that the radio equipment type, IMMOBILIZER, BAE-00 is in compliance with Directive 2014/53/EU.

The full text of the EU declaration of conformity is available at the following internet address:

https://global.yamaha-motor.com/eu_doc/

Frequency band: 134.2 kHz

The maximum radio frequency power: 49.0 [dB μ V/m]

Manufacturer:

YAMAHA MOTOR ELECTRONICS Co., Ltd

1450-6 Mori, Mori-machi, Shuchi-Gun, Shizuoka, 437-0292 Japan

Importer:

YAMAHA MOTOR EUROPE N.V.

Koolhovenlaan 101, 1119 NC Schiphol-Rijk, 1117 ZN, Schiphol, the Netherlands

Welcome to the Yamaha world of motorcycling!

As the owner of the MTM850, you are benefiting from Yamaha's vast experience and newest technology regarding the design and manufacture of high-quality products, which have earned Yamaha a reputation for dependability.

Please take the time to read this manual thoroughly, so as to enjoy all advantages of your MTM850. The Owner's Manual does not only instruct you in how to operate, inspect and maintain your motorcycle, but also in how to safeguard yourself and others from trouble and injury.

In addition, the many tips given in this manual will help keep your motorcycle in the best possible condition. If you have any further questions, do not hesitate to contact your Yamaha dealer.

The Yamaha team wishes you many safe and pleasant rides. So, remember to put safety first!

Yamaha continually seeks advancements in product design and quality. Therefore, while this manual contains the most current product information available at the time of printing, there may be minor discrepancies between your motorcycle and this manual. If there is any question concerning this manual, please consult a Yamaha dealer.





Please read this manual carefully and completely before operating this motorcycle.

Important manual information

EAU10134

Particularly important information is distinguished in this manual by the following notations:

	This is the safety alert symbol. It is used to alert you to potential personal injury hazards. Obey all safety messages that follow this symbol to avoid possible injury or death.
	A WARNING indicates a hazardous situation which, if not avoided, could result in death or serious injury.
	A NOTICE indicates special precautions that must be taken to avoid damage to the vehicle or other property.
TIP	A TIP provides key information to make procedures easier or clearer.

*Product and specifications are subject to change without notice.

EAU10201

**MTM850
OWNER'S MANUAL
©2019 by Yamaha Motor Co., Ltd.
1st edition, August 2018
All rights reserved.
Any reprinting or unauthorized use
without the written permission of
Yamaha Motor Co., Ltd.
is expressly prohibited.
Printed in Japan.**

Table of contents

Safety information	1-1	Luggage strap holders	3-26	Checking the engine idling speed.....	6-15
Description	2-1	Auxiliary DC connector.....	3-26	Checking the throttle grip free play.....	6-15
Left view	2-1	Sidestand	3-27	Valve clearance	6-15
Right view	2-2	Ignition circuit cut-off system.....	3-27	Tires.....	6-16
Controls and instruments.....	2-3			Cast wheels	6-18
Instrument and control functions ...	3-1	For your safety – pre-operation checks	4-1	Adjusting the clutch lever free play.....	6-18
Immobilizer system.....	3-1	Operation and important riding points	5-1	Checking the brake lever free play.....	6-19
Main switch/steering lock.....	3-2	Starting the engine	5-1	Brake light switches	6-20
Indicator lights and warning lights.....	3-3	Shifting	5-2	Checking the front and rear brake pads.....	6-20
Multi-function meter unit	3-6	Tips for reducing fuel consumption	5-3	Checking the brake fluid level.....	6-21
D-mode (drive mode).....	3-12	Engine break-in	5-3	Changing the brake fluid	6-22
Handlebar switches	3-13	Parking	5-4	Drive chain slack.....	6-22
Clutch lever.....	3-14			Cleaning and lubricating the drive chain	6-24
Shift pedal.....	3-15	Periodic maintenance and adjustment	6-1	Checking and lubricating the cables	6-25
Brake lever	3-15	Tool kit.....	6-2	Checking and lubricating the throttle grip and cable.....	6-25
Brake pedal	3-16	Periodic maintenance charts.....	6-3	Checking and lubricating the brake and shift pedals	6-25
ABS	3-16	Periodic maintenance chart for the emission control system	6-3	Checking and lubricating the brake and clutch levers	6-26
Traction control system	3-17	General maintenance and lubrication chart	6-5	Checking and lubricating the sidestand	6-27
Fuel tank cap	3-18	Checking the spark plugs.....	6-9	Lubricating the swingarm pivots.....	6-27
Fuel.....	3-19	Canister.....	6-10		
Fuel tank breather hose and overflow hose	3-21	Engine oil	6-10		
Catalytic converter.....	3-21	Why Yamalube	6-13		
Seat	3-22	Coolant.....	6-13		
Storage compartment.....	3-22	Air filter element	6-14		
Adjusting the front fork.....	3-23				
Adjusting the shock absorber assembly	3-24				

Table of contents

- Checking the front fork 6-27
- Checking the steering..... 6-28
- Checking the wheel bearings 6-28
- Battery 6-29
- Replacing the fuses..... 6-30
- Replacing the headlight bulb 6-33
- Replacing the auxiliary light
bulb 6-34
- Brake/tail light..... 6-35
- Replacing a turn signal light
bulb 6-35
- License plate light..... 6-36
- Supporting the motorcycle..... 6-36
- Troubleshooting..... 6-36
- Troubleshooting charts..... 6-38

- Motorcycle care and storage** 7-1
 - Matte color caution 7-1
 - Care..... 7-1
 - Storage..... 7-3

- Specifications** 8-1

- Consumer information** 9-1
 - Identification numbers 9-1
 - Diagnostic connector 9-2
 - Vehicle data recording..... 9-2

- Index** 10-1

Safety information

EAU1028C

1

Be a Responsible Owner

As the vehicle's owner, you are responsible for the safe and proper operation of your motorcycle.

Motorcycles are single-track vehicles. Their safe use and operation are dependent upon the use of proper riding techniques as well as the expertise of the operator. Every operator should know the following requirements before riding this motorcycle.

He or she should:

- Obtain thorough instructions from a competent source on all aspects of motorcycle operation.
- Observe the warnings and maintenance requirements in this Owner's Manual.
- Obtain qualified training in safe and proper riding techniques.
- Obtain professional technical service as indicated in this Owner's Manual and/or when made necessary by mechanical conditions.
- Never operate a motorcycle without proper training or instruction.

Take a training course. Beginners should receive training from a certified instructor. Contact an authorized motorcycle dealer to find out about the training courses nearest you.

Safe Riding

Perform the pre-operation checks each time you use the vehicle to make sure it is in safe operating condition. Failure to inspect or maintain the vehicle properly increases the possibility of an accident or equipment damage. See page 4-1 for a list of pre-operation checks.

- This motorcycle is designed to carry the operator and a passenger.
- The failure of motorists to detect and recognize motorcycles in traffic is the predominating cause of automobile/motorcycle accidents. Many accidents have been caused by an automobile driver who did not see the motorcycle. Making yourself conspicuous appears to be very effective in reducing the chance of this type of accident.

Therefore:

- Wear a brightly colored jacket.

- Use extra caution when you are approaching and passing through intersections, since intersections are the most likely places for motorcycle accidents to occur.
- Ride where other motorists can see you. Avoid riding in another motorist's blind spot.
- Never maintain a motorcycle without proper knowledge. Contact an authorized motorcycle dealer to inform you on basic motorcycle maintenance. Certain maintenance can only be carried out by certified staff.
- Many accidents involve inexperienced operators. In fact, many operators who have been involved in accidents do not even have a current motorcycle license.
- Make sure that you are qualified and that you only lend your motorcycle to other qualified operators.
- Know your skills and limits. Staying within your limits may help you to avoid an accident.
- We recommend that you prac-

tice riding your motorcycle where there is no traffic until you have become thoroughly familiar with the motorcycle and all of its controls.

- Many accidents have been caused by error of the motorcycle operator. A typical error made by the operator is veering wide on a turn due to excessive speed or undercornering (insufficient lean angle for the speed).
- Always obey the speed limit and never travel faster than warranted by road and traffic conditions.
- Always signal before turning or changing lanes. Make sure that other motorists can see you.
- The posture of the operator and passenger is important for proper control.
 - The operator should keep both hands on the handlebar and both feet on the operator footrests during operation to maintain control of the motorcycle.
 - The passenger should always hold onto the operator, the seat strap or grab bar, if equipped,

with both hands and keep both feet on the passenger footrests. Never carry a passenger unless he or she can firmly place both feet on the passenger footrests.

- Never ride under the influence of alcohol or other drugs.
- This motorcycle is designed for on-road use only. It is not suitable for off-road use.

Protective Apparel

The majority of fatalities from motorcycle accidents are the result of head injuries. The use of a safety helmet is the single most critical factor in the prevention or reduction of head injuries.

- Always wear an approved helmet.
- Wear a face shield or goggles. Wind in your unprotected eyes could contribute to an impairment of vision that could delay seeing a hazard.
- The use of a jacket, heavy boots, trousers, gloves, etc., is effective in preventing or reducing abrasions or lacerations.
- Never wear loose-fitting clothes, otherwise they could catch on the

control levers, footrests, or wheels and cause injury or an accident.

- Always wear protective clothing that covers your legs, ankles, and feet. The engine or exhaust system become very hot during or after operation and can cause burns.
- A passenger should also observe the above precautions.

Avoid Carbon Monoxide Poisoning

All engine exhaust contains carbon monoxide, a deadly gas. Breathing carbon monoxide can cause headaches, dizziness, drowsiness, nausea, confusion, and eventually death.

Carbon Monoxide is a colorless, odorless, tasteless gas which may be present even if you do not see or smell any engine exhaust. Deadly levels of carbon monoxide can collect rapidly and you can quickly be overcome and unable to save yourself. Also, deadly levels of carbon monoxide can linger for hours or days in enclosed or poorly ventilated areas. If you experience any symptoms of carbon monoxide poisoning, leave the area immediately, get fresh air, and SEEK MEDICAL TREAT-

Safety information

1

MENT.

- Do not run engine indoors. Even if you try to ventilate engine exhaust with fans or open windows and doors, carbon monoxide can rapidly reach dangerous levels.
- Do not run engine in poorly ventilated or partially enclosed areas such as barns, garages, or carports.
- Do not run engine outdoors where engine exhaust can be drawn into a building through openings such as windows and doors.

Loading

Adding accessories or cargo to your motorcycle can adversely affect stability and handling if the weight distribution of the motorcycle is changed. To avoid the possibility of an accident, use extreme caution when adding cargo or accessories to your motorcycle. Use extra care when riding a motorcycle that has added cargo or accessories. Here, along with the information about accessories below, are some general guidelines to follow if loading cargo to your motorcycle:

The total weight of the operator, passenger, accessories and cargo must not exceed the maximum load limit.

Operation of an overloaded vehicle could cause an accident.

Maximum load: 170 kg (375 lb)

When loading within this weight limit, keep the following in mind:

- Cargo and accessory weight should be kept as low and close to the motorcycle as possible. Securely pack your heaviest items as close to the center of the vehicle as possible and make sure to distribute the weight as evenly as possible on both sides of the motorcycle to minimize imbalance or instability.
- Shifting weights can create a sudden imbalance. Make sure that accessories and cargo are securely attached to the motorcycle before riding. Check accessory mounts and cargo restraints frequently.
 - Properly adjust the suspension for your load (suspension-ad-

justable models only), and check the condition and pressure of your tires.

- Never attach any large or heavy items to the handlebar, front fork, or front fender. These items, including such cargo as sleeping bags, duffel bags, or tents, can create unstable handling or a slow steering response.
- **This vehicle is not designed to pull a trailer or to be attached to a sidecar.**

Genuine Yamaha Accessories

Choosing accessories for your vehicle is an important decision. Genuine Yamaha accessories, which are available only from a Yamaha dealer, have been designed, tested, and approved by Yamaha for use on your vehicle.

Many companies with no connection to Yamaha manufacture parts and accessories or offer other modifications for Yamaha vehicles. Yamaha is not in a position to test the products that these aftermarket companies produce. Therefore, Yamaha can neither en-

dorse nor recommend the use of accessories not sold by Yamaha or modifications not specifically recommended by Yamaha, even if sold and installed by a Yamaha dealer.

Aftermarket Parts, Accessories, and Modifications

While you may find aftermarket products similar in design and quality to genuine Yamaha accessories, recognize that some aftermarket accessories or modifications are not suitable because of potential safety hazards to you or others. Installing aftermarket products or having other modifications performed to your vehicle that change any of the vehicle's design or operation characteristics can put you and others at greater risk of serious injury or death. You are responsible for injuries related to changes in the vehicle.

Keep the following guidelines in mind, as well as those provided under "Loading" when mounting accessories.

- Never install accessories or carry cargo that would impair the performance of your motorcycle. Carefully inspect the accessory before

using it to make sure that it does not in any way reduce ground clearance or cornering clearance, limit suspension travel, steering travel or control operation, or obscure lights or reflectors.

- Accessories fitted to the handlebar or the front fork area can create instability due to improper weight distribution or aerodynamic changes. If accessories are added to the handlebar or front fork area, they must be as lightweight as possible and should be kept to a minimum.
- Bulky or large accessories may seriously affect the stability of the motorcycle due to aerodynamic effects. Wind may attempt to lift the motorcycle, or the motorcycle may become unstable in cross winds. These accessories may also cause instability when passing or being passed by large vehicles.
- Certain accessories can displace the operator from his or her normal riding position. This improper position limits the free-

dom of movement of the operator and may limit control ability, therefore, such accessories are not recommended.

- Use caution when adding electrical accessories. If electrical accessories exceed the capacity of the motorcycle's electrical system, an electric failure could result, which could cause a dangerous loss of lights or engine power.

Aftermarket Tires and Rims

The tires and rims that came with your motorcycle were designed to match the performance capabilities and to provide the best combination of handling, braking, and comfort. Other tires, rims, sizes, and combinations may not be appropriate. See page 6-16 for tire specifications and for information on servicing and replacing your tires.

Transporting the Motorcycle

Be sure to observe following instructions before transporting the motorcycle in another vehicle.

- Remove all loose items from the motorcycle.

Safety information

1

- Check that the fuel cock (if equipped) is in the off position and that there are no fuel leaks.
- Shift the transmission into gear (for models with a manual transmission).
- Secure the motorcycle with tie-downs or suitable straps that are attached to solid parts of the motorcycle, such as the frame or upper front fork triple clamp (and not, for example, to rubber-mounted handlebars or turn signals, or parts that could break). Choose the location for the straps carefully so the straps will not rub against painted surfaces during transport.
- The suspension should be compressed somewhat by the tie-downs, if possible, so that the motorcycle will not bounce excessively during transport.

Left view

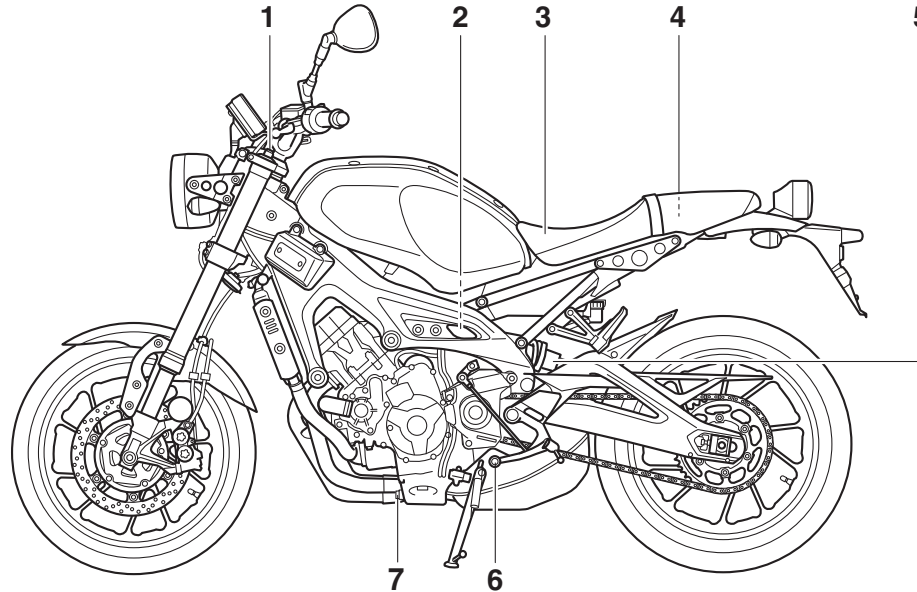

1. Spring preload adjuster (page 3-23)
2. Rebound damping force adjuster (page 3-24)
3. Seat (page 3-22)
4. Storage compartment (page 3-22)
5. Spring preload adjuster (page 3-24)
6. Shift pedal (page 3-15)
7. Engine oil drain bolt (page 6-10)

Description

EAU10421

Right view

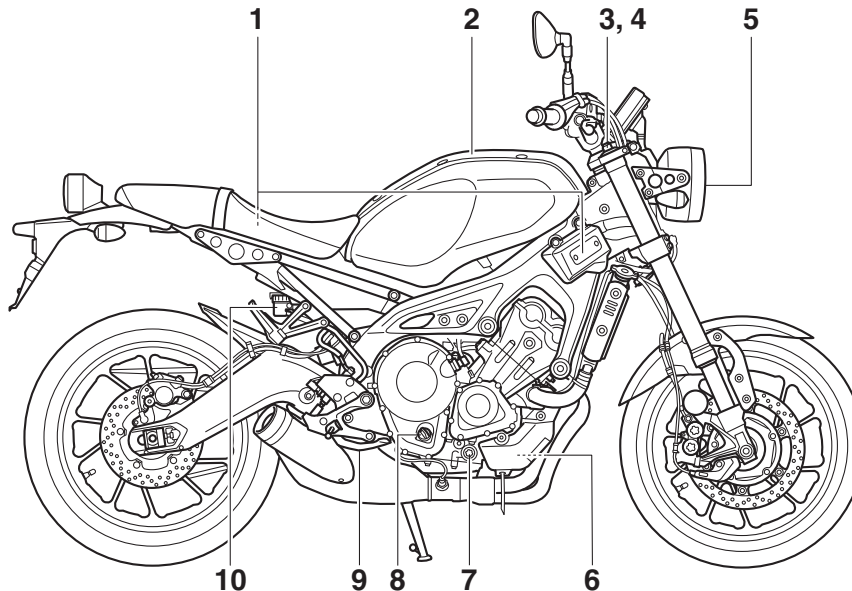

1. Fuses (page 6-30)
2. Fuel tank cap (page 3-18)
3. Spring preload adjuster (page 3-23)
4. Rebound damping force adjuster (page 3-23)
5. Headlight (page 6-33)
6. Coolant reservoir (page 6-13)
7. Engine oil level check window (page 6-10)
8. Engine oil filler cap (page 6-10)
9. Brake pedal (page 3-16)
10. Rear brake fluid reservoir (page 6-21)

Controls and instruments

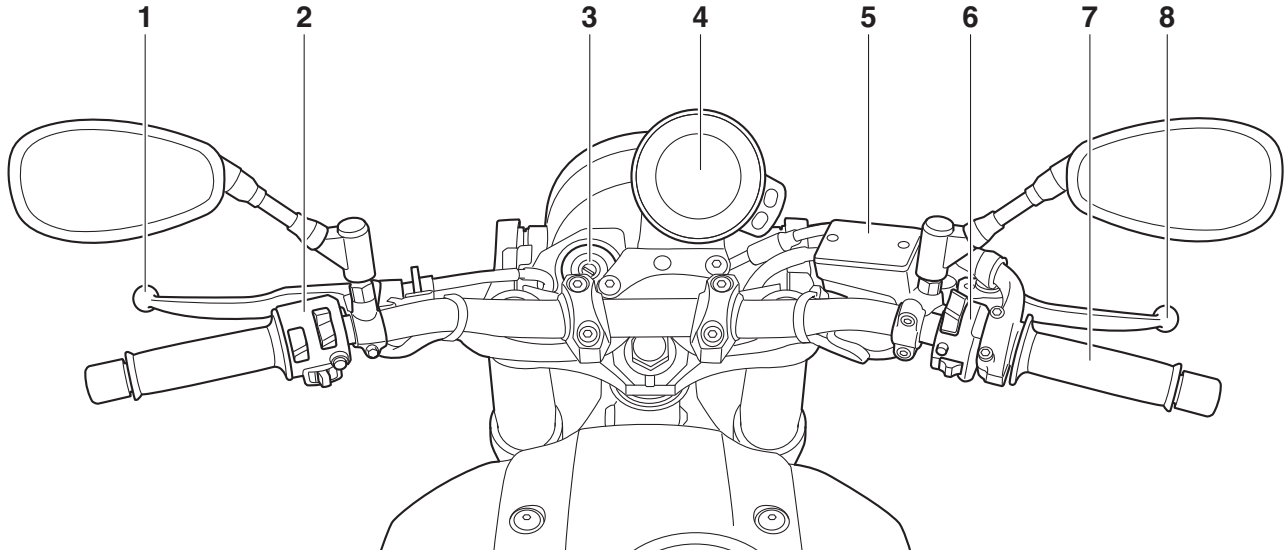

1. Clutch lever (page 3-14)
2. Left handlebar switches (page 3-13)
3. Main switch/steering lock (page 3-2)
4. Multi-function meter unit (page 3-6)
5. Front brake fluid reservoir (page 6-21)
6. Right handlebar switches (page 3-13)
7. Throttle grip (page 6-15)
8. Brake lever (page 3-15)

Instrument and control functions

3

Immobilizer system

EAU10979

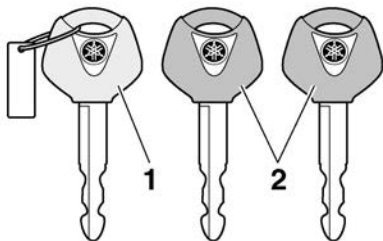

1. Code re-registering key (red bow)
2. Standard keys (black bow)

This vehicle is equipped with an immobilizer system to help prevent theft by re-registering codes in the standard keys. This system consists of the following:

- a code re-registering key
- two standard keys
- a transponder (in each key)
- an immobilizer unit (on the vehicle)
- an ECU (on the vehicle)
- a system indicator light (page 3-5)

About the keys

The key with the red bow is used to register codes in each standard key. Store

the code re-registering key in a safe place. When necessary, take the vehicle along with all three keys to a Yamaha dealer to have them re-registered.

Do not use the key with the red bow for driving. It should only be used for re-registering the standard keys. Always use a standard key for driving.

TIP

- Keep the standard keys as well as keys of other immobilizer systems away from the code re-registering key.
- Keep other immobilizer system keys away from the main switch as they may cause signal interference.

ECA11823

NOTICE

DO NOT LOSE THE CODE RE-REGISTERING KEY! CONTACT YOUR DEALER IMMEDIATELY IF IT IS LOST! If the code re-registering key is lost, the existing standard keys can still be used to start the vehicle. However, registering a new standard key is impossible. If all keys

have been lost or damaged, the entire immobilizer system must be replaced. Therefore, handle the keys carefully.

- Do not submerge in water.
- Do not expose to high temperatures.
- Do not place near magnets.
- Do not place near items that transmit electrical signals.
- Do not handle roughly.
- Do not grind or alter.
- Do not disassemble.
- Do not put two keys of any immobilizer system on the same key ring.

Main switch/steering lock

EAU10474

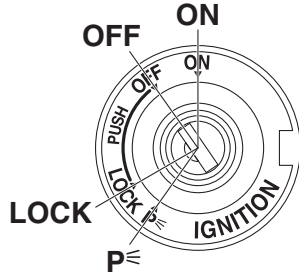

The main switch/steering lock controls the ignition and lighting systems, and is used to lock the steering. The various positions are described below.

TIP

Be sure to use the standard key (black bow) for regular use of the vehicle. To minimize the risk of losing the code re-registering key (red bow), keep it in a safe place and only use it for code re-registering.

ON

EAU85040

All electrical circuits are supplied with power and the vehicle lights are turned

on. The engine can be started. The key cannot be removed.

TIP

- To prevent battery discharge, do not leave the key in the on position without the engine running.
- The headlight comes on automatically when the engine is started.

OFF

All electrical systems are off. The key can be removed.

EAU10662

WARNING

Never turn the key to “OFF” or “LOCK” while the vehicle is moving. Otherwise the electrical systems will be switched off, which may result in loss of control or an accident.

EWA10062

LOCK

The steering is locked and all electrical systems are off. The key can be removed.

EAU1068B

To lock the steering

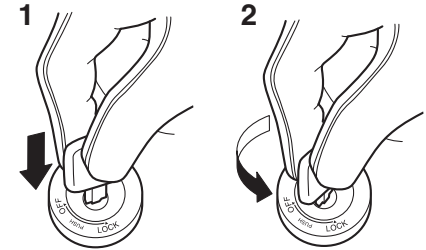

1. Push.
2. Turn.

1. Turn the handlebars all the way to the left.
2. With the key in the “OFF” position, push the key in and turn it to “LOCK”.
3. Remove the key.

TIP

If the steering will not lock, try turning the handlebars back to the right slightly.

Instrument and control functions

To unlock the steering

may cause the battery to discharge.

EAU4939G

Indicator lights and warning lights

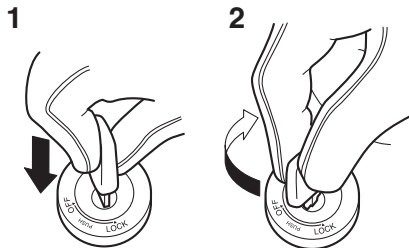

1. Push.
2. Turn.

From the “LOCK” position, push the key in and turn it to “OFF”.

EAU59680

p⊆ (Parking)

The hazard lights and turn signal lights can be turned on, but all other electrical systems are off. The key can be removed.

The steering must be locked before the key can be turned to “p⊆”.

ECA20760

NOTICE

Using the hazard or turn signal lights for an extended length of time

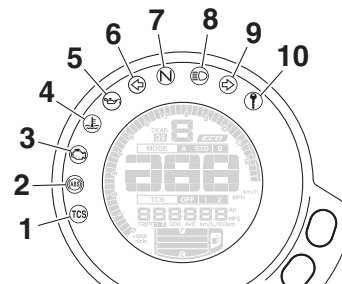

1. Traction control system indicator light “TCS”
2. ABS warning light “⊗”
3. Engine trouble warning light “⊠”
4. Coolant temperature warning light “⊡”
5. Oil level warning light “⊢”
6. Left turn signal indicator light “⊣”
7. Neutral indicator light “N”
8. High beam indicator light “≡D”
9. Right turn signal indicator light “⊤”
10. Immobilizer system indicator light “⊥”

EAU11032

Turn signal indicator lights “⊣” and “⊤”

Each indicator light will flash when its corresponding turn signal lights are

flashing.

Neutral indicator light “N”

EAU11061

This indicator light comes on when the transmission is in the neutral position.

High beam indicator light “”

EAU11081

This indicator light comes on when the high beam of the headlight is switched on.

Oil level warning light “”

EAU11259

This warning light comes on when the engine oil level is low. To prevent engine damage, replenish the engine oil as soon as possible.

Even if the oil level is sufficient, the warning light may flicker when riding on a slope or during sudden acceleration or deceleration, but this is not a malfunction. If a problem is detected in the oil level detection circuit, the oil level warning light will flash repeatedly. If this occurs, have a Yamaha dealer check the vehicle.

TIP

When the vehicle is turned on, this light will come on for a few seconds and then go off. If the light does not come on, or if the light remains on after confirming that the oil level is correct (see page 6-10), have a Yamaha dealer check the vehicle.

Coolant temperature warning light

“”

EAU11449

This warning light comes on when the engine is overheating. If this occurs, stop the engine immediately and allow the engine to cool. (See page 6-39.) For vehicles with a radiator fan, the radiator fan(s) automatically switch on or off according to the coolant temperature.

TIP

When the vehicle is turned on, the light will come on for a few seconds, and then go off. If the light does not come on, or if the light remains on, have a Yamaha dealer check the vehicle.

NOTICE

ECA10022

Do not continue to operate the engine if it is overheating.

Engine trouble warning light “”

EAU73172

This warning light comes on if a problem is detected in the engine or other vehicle control system. If this occurs, have a Yamaha dealer check the on-board diagnostic system.

TIP

When the vehicle is turned on, the light will come on for a few seconds and then go off. If the light does not come on, or if the light remains on, have a Yamaha dealer check the vehicle.

ABS warning light “”

EAU69892

This warning light comes on when the vehicle is first turned on, and goes off after starting riding. If the warning light comes on while riding, the anti-lock brake system may not work correctly. (See page 3-16.)

Instrument and control functions

TIP

If the light does not come at all, or if the light does not go off after traveling 10 km/h (6 mi/h), have a Yamaha dealer check the vehicle.

EWA16041

WARNING

If the ABS warning light does not go off after traveling at a speed of 10 km/h (6 mi/h) or higher, or if the warning light comes on or flashes while riding, the brake system reverts to conventional braking. If either of the above occurs, or if the warning light does not come on at all, use extra caution to avoid possible wheel lock during emergency braking. Have a Yamaha dealer check the brake system and electrical circuits as soon as possible.

EAU78591

Traction control system indicator light “TCS”

This indicator light will flash when traction control has engaged.

If the traction control system is turned off, this indicator light will come on.

(See page 3-17.)

TIP

When the vehicle is turned on, the light should come on for a few seconds and then go off. If the light does not come on, or if the light remains on, have a Yamaha dealer check vehicle.

EAUM3621

Immobilizer system indicator light

“ ? ”

When the key is turned to “OFF” and 30 seconds have passed, the indicator light will flash steadily to indicate the immobilizer system is enabled. After 24 hours have passed, the indicator light will stop flashing, however the immobilizer system is still enabled.

The electrical circuit of the indicator light can be checked by turning the key to “ON”. The indicator light should come on for a few seconds, and then go off.

If the indicator light does not come on initially when the key is turned to “ON”, if the indicator light remains on, or if the indicator light flashes in a pattern (if a problem is detected in the immobilizer

system, the immobilizer system indicator light will flash in a pattern), have a Yamaha dealer check the vehicle.

TIP

If the immobilizer system indicator light flashes in the pattern, slowly 5 times then quickly 2 times, this could be caused by transponder interference. If this occurs, try the following.

1. Make sure there are no other immobilizer keys close to the main switch. Other immobilizer system keys may cause signal interference and prevent the engine from starting.
2. Use the code re-registering key to start the engine.
3. If the engine starts, turn it off, and try starting the engine with the standard keys.
4. If one or both of the standard keys do not start the engine, take the vehicle and all 3 keys to a Yamaha dealer to have the standard keys re-registered.

Instrument and control functions

Multi-function meter unit

EAU73257

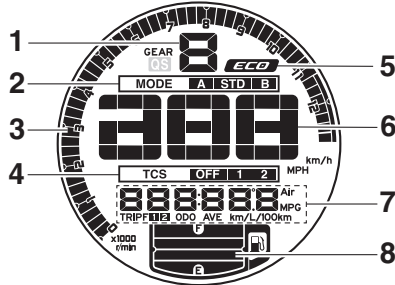

1. Transmission gear display
2. Drive mode display
3. Tachometer
4. TCS display
5. Eco indicator "ECO"
6. Speedometer
7. Multi-function display
8. Fuel meter

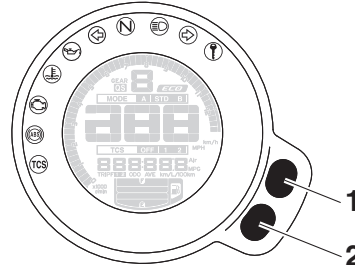

1. Top set button
2. Bottom set button

WARNING

EWA12423

Be sure to stop the vehicle before making any setting changes to the multi-function meter unit. Changing settings while riding can distract the operator and increase the risk of an accident.

The multi-function meter unit is equipped with the following:

- a speedometer
- a tachometer
- a fuel meter
- an eco indicator
- a transmission gear display
- a drive mode display

- a traction control system display
- a multi-function display

TIP

- The "QS" icon does not function.
- The multi-function meter unit can be switched between kilometers and miles. Set the multi-function display to the odometer mode or a tripmeter mode, and then press the bottom set button for three seconds.

3

Speedometer

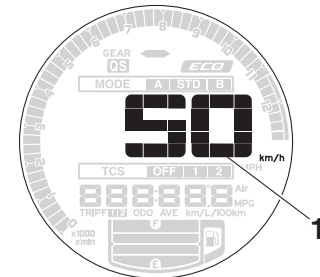

1. Speedometer

The speedometer shows the vehicle's traveling speed.

Instrument and control functions

Tachometer

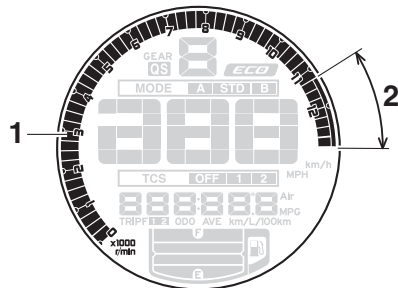

1. Tachometer
2. Tachometer red zone

The tachometer allows the rider to monitor the engine speed and keep it within the ideal power range.

ECA10032

NOTICE

Do not operate the engine in the tachometer red zone.

Red zone: 11250 r/min and above

Fuel meter

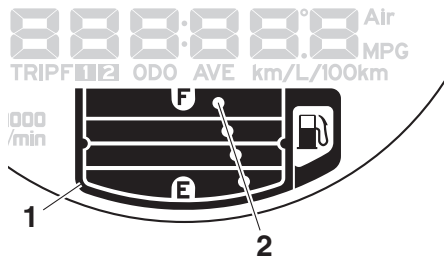

1. Frame
2. Segment

The fuel meter indicates the amount of fuel in the fuel tank. The display segments of the fuel meter disappear from “F” (full tank) towards “E” (empty tank) as the fuel level decreases. When the last segment and frame start flashing, refuel as soon as possible.

TIP

If a problem is detected in the fuel tank electrical circuit, the fuel level segments, frame, and “F” will flash repeatedly. Have a Yamaha dealer check the vehicle.

Eco indicator

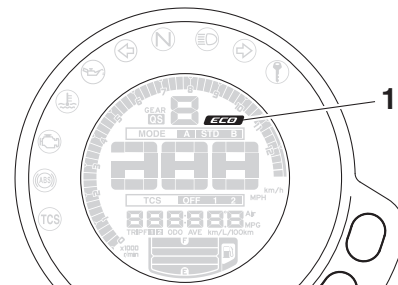

1. Eco indicator “ECO”

This indicator comes on when the vehicle is being operated in an environmentally friendly, fuel-efficient manner. The indicator goes off when the vehicle is stopped.

TIP

Consider the following tips to reduce fuel consumption:

- Avoid high engine speeds during acceleration.
- Travel at a constant speed.
- Select the transmission gear that is appropriate for the vehicle speed.

Instrument and control functions

Transmission gear display

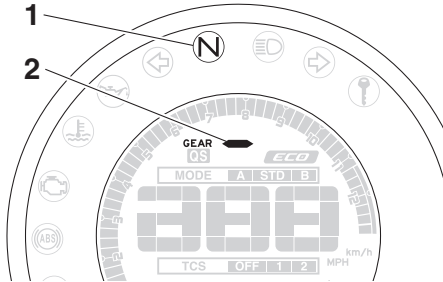

1. Neutral indicator light “N”
2. Transmission gear display

This display shows the selected gear. The neutral position is indicated by “N” and by the neutral indicator light.

Drive mode display

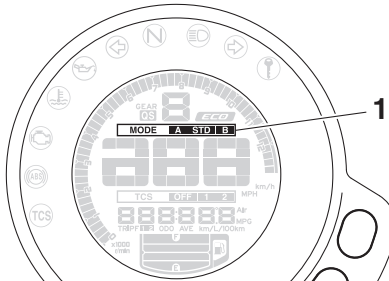

1. Drive mode display

This display indicates which drive mode has been selected: “STD”, “A” or “B”. For more details on the modes and on how to select them, see pages 3-12 and 3-14.

TCS display

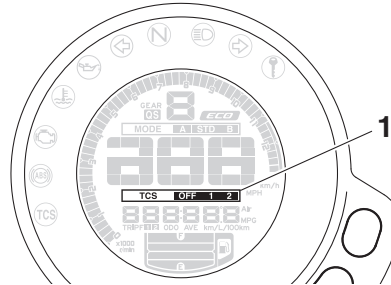

1. TCS display

This display indicates which traction control system setting has been selected: “1”, “2” or “OFF”. For more details on the TCS settings and on how to select them, see page 3-17.

Multi-function display

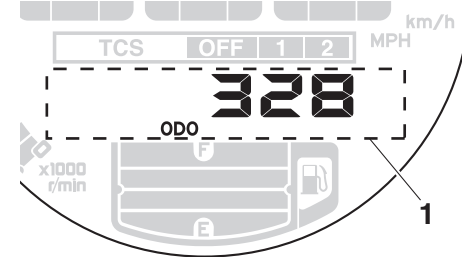

1. Multi-function display

The multi-function display is equipped with the following:

- an odometer
- two tripmeters
- a fuel reserve tripmeter
- an instantaneous fuel consumption display
- an average fuel consumption display
- a coolant temperature display
- an air temperature display
- a clock
- a brightness level display

The odometer “ODO” shows the total distance the vehicle has traveled.

Instrument and control functions

The tripmeters “TRIP” show the distance traveled since they were last reset.

To reset a tripmeter, select it by pushing the bottom set button. The tripmeter will flash for a few seconds. While the tripmeter is flashing, push the top set button for one second.

TIP

- The odometer will lock at 999999.
- The tripmeters will reset and continue counting after 9999.9 is reached.

Changing the display item

Push the bottom set button to switch the display between odometer “ODO”, tripmeters “TRIP 1” and “TRIP 2”, instantaneous fuel consumption “km/L” or “L/100 km”, average fuel consumption “AVE_ _ _ km/L” or “AVE_ _ _ L/100 km”, coolant temperature “_ _ °C”, ambient temperature “Air_ _ °C”, and clock “_ _ : _ _” in the following order:

ODO → TRIP 1 → TRIP 2 → (TRIP F)
→ km/L or L/100 km → AVE_ _ _ km/L

or AVE_ _ _ L/100 km → _ _ °C → Air
_ _ °C → Clock _ _ : _ _ → ODO

When using miles:

ODO → TRIP 1 → TRIP 2 → (TRIP F)
→ MPG → AVE_ _ _ MPG → _ _ °C →
Air_ _ °C → Clock _ _ : _ _ → ODO

TIP

- Push the top set button to switch the display in the reverse order.
- The fuel reserve tripmeter “TRIP F” appears only when low on fuel.

When low on fuel, the display automatically changes to “TRIP F” and starts counting the distance traveled from that point.

If you do not reset the fuel reserve tripmeter manually, after refueling and traveling 5 km (3 mi) it resets automatically and disappears from the display.

Instantaneous fuel consumption

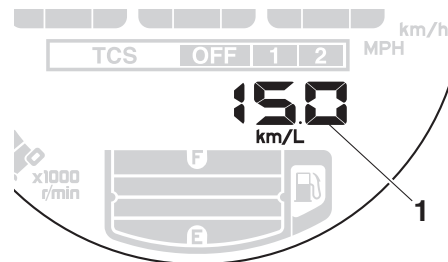

1. Instantaneous fuel consumption display

The instantaneous fuel consumption display can be set to either “km/L” or “L/100 km”; or when using miles, to “MPG” as well.

- “km/L”: The distance that can be traveled on 1.0 L of fuel under current riding conditions.
- “L/100 km”: The amount of fuel necessary to travel 100 km under current riding conditions.
- “MPG”: The distance that can be traveled on 1.0 Imp.gal of fuel under current riding conditions.

To switch the instantaneous fuel consumption display settings, push the bottom set button for two seconds.

TIP _____
If traveling at speeds under 20 km/h (12 mi/h), “_ _ _” is displayed.

Average fuel consumption

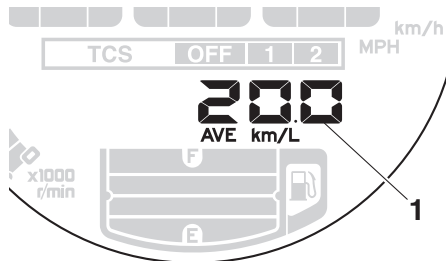

1. Average fuel consumption display

This display shows the average fuel consumption since it was last reset. The average fuel consumption display can be set to either “AVE_ _ _ km/L” or “AVE_ _ _ L/100 km”, or when using miles, to “AVE_ _ _ MPG” as well.

- “AVE_ _ _ km/L”: The average distance that can be traveled on 1.0 L of fuel.
- “AVE_ _ _ L/100 km”: The average amount of fuel necessary to travel 100 km.

- “AVE_ _ _ MPG”: The average distance that can be traveled on 1.0 Imp.gal of fuel.

To switch the average fuel consumption display settings, push the bottom set button for two seconds.

To reset the average fuel consumption, select it by pushing the bottom set button. The average fuel consumption display will flash for a few seconds. While the display is flashing, push the top set button for one second.

TIP _____
After resetting the average fuel consumption, “_ _ _” will be shown until the vehicle has traveled 1 km (0.6 mi).

Coolant temperature

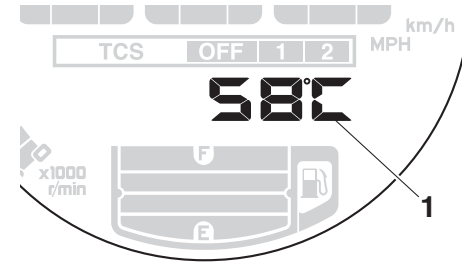

1. Coolant temperature display

This display shows the coolant temperature from 40 °C to 116 °C in 1 °C increments.

If the message “HI” flashes, stop the vehicle, then stop the engine and let it cool. (See page 6-39.)

TIP _____

- When the coolant temperature is below 40 °C, “Lo” will be displayed.
- The coolant temperature varies with changes in the weather and engine load.

Instrument and control functions

Air temperature

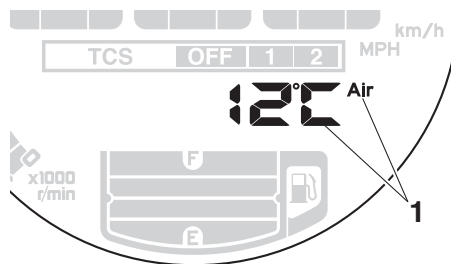

1. Air temperature display

This display shows the air temperature from -9°C to 99°C in 1°C increments. The temperature displayed may vary from the actual ambient temperature.

TIP

- When the air temperature is below -9°C , "Lo" will be displayed.
- The accuracy of the temperature reading may be affected when riding slowly (under 20 km/h [12 mi/h]) or when stopped at traffic signals, railroad crossings, etc.

Clock

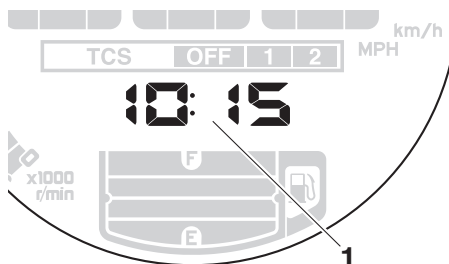

1. Clock

The clock uses a 12-hour time system. When the vehicle is turned off, the clock can be viewed by pushing the bottom set button.

To set the clock

1. Turn the main switch on.
2. Switch the display to the clock.
3. Push the bottom set button and top set button together for two seconds and the hour digits will start flashing.
4. Push the top set button to set the hours.
5. Push the bottom set button and the minute digits will start flashing.

6. Push the top set button to set the minutes.
7. Push the bottom set button to confirm settings and start the clock.

TIP

When setting the hours and minutes, push the top set button briefly to increase the increment value one by one, or push and hold the button to increase the increment value continuously.

Brightness control

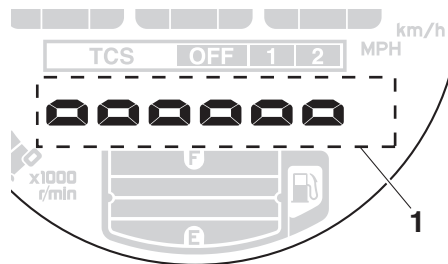

1. Brightness level display

The brightness level of the multi-function meter unit panel can be adjusted to six brightness level settings.

To adjust the brightness

1. Turn the main switch off.
2. Push and hold the bottom set button.
3. Turn the main switch on and continue pushing the bottom set button until the display switches to the brightness level display.
4. Push the top set button to set the brightness level.
5. Push the bottom set button to confirm the selected brightness level and exit the brightness level display.

D-mode (drive mode)

EAU47636

D-mode is an electronically controlled engine performance system with three mode selections: “STD”, “A”, and “B”. Push the drive mode switch “MODE” to switch between modes. (See page 3-14.)

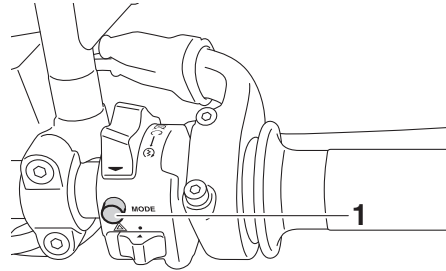

1. Drive mode switch “MODE”

TIP

Before using D-mode, make sure you understand its operation along with the operation of the drive mode switch.

Mode “STD”

Mode “STD” is suitable for various riding conditions.

This mode allows the rider to enjoy

smooth and sporty drivability from the low-speed range to the high-speed range.

Mode “A”

Mode “A” offers a sportier engine response in the low- to mid-speed range compared to mode “STD”.

Mode “B”

Mode “B” offers response that is somewhat less sharp compared to mode “STD” for riding situations that require especially sensitive throttle operation.

Instrument and control functions

Handlebar switches

EAU1234M

Left

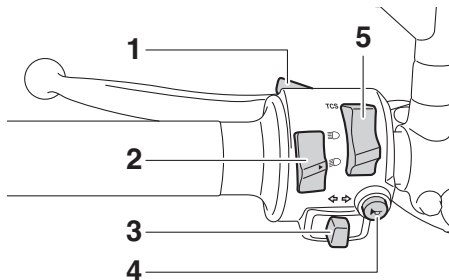

1. Pass switch “≡〇”
2. Dimmer switch “≡〇/≡〇”
3. Turn signal switch “↔/↔”
4. Horn switch “📢”
5. Traction control system switch “TCS”

Right

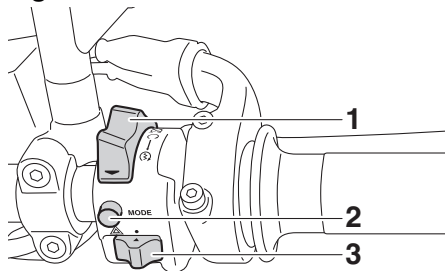

1. Stop/Run/Start switch “⏹/〇/⏻”
2. Drive mode switch “MODE”
3. Hazard switch “▲”

Pass switch “≡〇”

Press this switch to flash the headlight.

EAU12352

TIP

When the dimmer switch is set to “≡〇”, the passing switch has no effect.

EAU12402

Dimmer switch “≡〇/≡〇”

Set this switch to “≡〇” for the high beam and to “≡〇” for the low beam.

EAU12461

Turn signal switch “↔/↔”

To signal a right-hand turn, push this switch to “↔”. To signal a left-hand turn, push this switch to “↔”. When released, the switch returns to the center position. To cancel the turn signal lights, push the switch in after it has returned to the center position.

EAU12501

Horn switch “📢”

Press this switch to sound the horn.

EAU73391

Traction control system switch “TCS”

With the throttle closed, push this switch down to change from TCS “1” to “2”. Push up to change from TCS “2” to “1”.

With the vehicle stopped, push this switch up for two seconds to turn the system off. Push down to turn the system on.



TIP

- The current TCS setting is shown in the TCS display (page 3-8).
- See page 3-17 for an explanation

of the traction control system and the TCS settings.

EAU54212

Stop/Run/Start switch “”

To crank the engine with the starter, set this switch to “”, and then push the switch down towards “”. See page 5-1 for starting instructions prior to starting the engine.

Set this switch to “” to stop the engine in case of an emergency, such as when the vehicle overturns or when the throttle cable is stuck.

EAU12735

Hazard switch “”

With the key in the “ON” or “” position, use this switch to turn on the hazard lights (simultaneous flashing of all turn signal lights).

The hazard lights are used in case of an emergency or to warn other drivers when your vehicle is stopped where it might be a traffic hazard.

ECA10062

NOTICE

Do not use the hazard lights for an extended length of time with the en-

gine not running, otherwise the battery may discharge.

EAU73321

Drive mode switch “MODE”

EWA18440

WARNING

Do not change the drive mode while the vehicle is moving.

With the throttle grip closed, press this switch to change the drive mode (page 3-12) in the following order:

A → B → STD → A

TIP

- The current drive mode is shown in the drive mode display (page 3-8).
- The current drive mode is saved when the vehicle is turned off.

Clutch lever

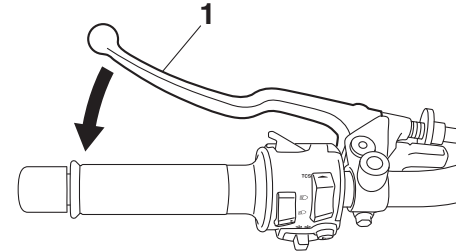

1. Clutch lever

The clutch lever is located on the left side of the handlebar. To disengage the clutch, pull the lever toward the handlebar grip. To engage the clutch, release the lever. The lever should be pulled rapidly and released slowly for smooth clutch operation.

The clutch lever is equipped with a clutch switch, which is part of the ignition circuit cut-off system. (See page 3-27.)

Instrument and control functions

EAU12876

Shift pedal

3

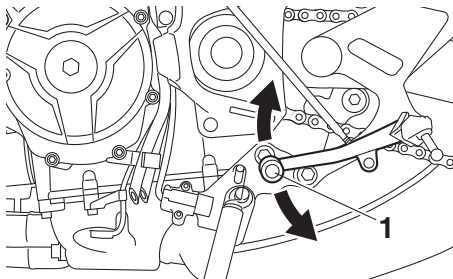

1. Shift pedal

The shift pedal is located on the left side of the motorcycle. To shift the transmission to a higher gear, move the shift pedal up. To shift the transmission to a lower gear, move the shift pedal down. (See page 5-2.)

EAU26826

Brake lever

The brake lever is located on the right side of the handlebar. To apply the front brake, pull the lever toward the throttle grip.

the brake lever.

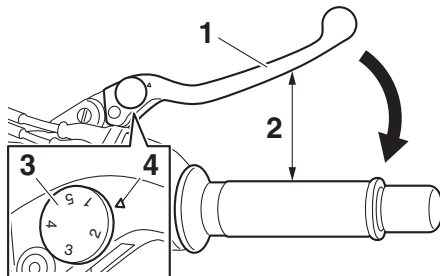

1. Brake lever
2. Distance between brake lever and throttle grip
3. Brake lever position adjusting dial
4. Match mark

The brake lever is equipped with a brake lever position adjusting dial. To adjust the distance between the brake lever and the throttle grip, slightly pull the brake lever away from the throttle grip and rotate the adjusting dial. Make sure the setting number on the adjusting dial aligns with the match mark on

Brake pedal

EAU12944

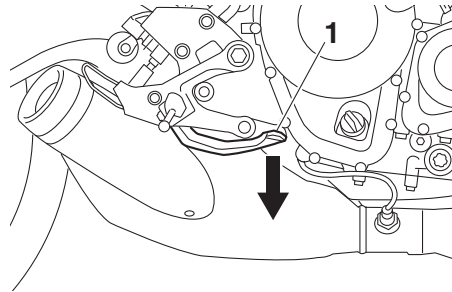

1. Brake pedal

The brake pedal is located on the right side of the motorcycle. To apply the rear brake, press down on the brake pedal.

ABS

EAU63040

The Yamaha ABS (Anti-lock Brake System) features a dual electronic control system, which acts on the front and rear brakes independently. Operate the brakes with ABS as you would conventional brakes. If the ABS is activated, a pulsating sensation may be felt at the brake lever or brake pedal. In this situation, continue to apply the brakes and let the ABS work; do not “pump” the brakes as this will reduce braking effectiveness.

EWA16051

WARNING

Always keep a sufficient distance from the vehicle ahead to match the riding speed even with ABS.

- **The ABS performs best with long braking distances.**
- **On certain surfaces, such as rough or gravel roads, the braking distance may be longer with the ABS than without.**

The ABS is monitored by an ECU, which will revert the system to conventional braking if a malfunction occurs.

TIP

- The ABS performs a self-diagnosis test each time the vehicle first starts off after the key is turned to “ON” and the vehicle has traveled at a speed of 10 km/h (6 mi/h) or higher. During this test, a “clicking” noise can be heard from the hydraulic control unit, and if the brake lever or brake pedal is even slightly applied, a vibration can be felt at the lever and pedal, but these do not indicate a malfunction.
- This ABS has a test mode which allows the owner to experience the pulsation at the brake lever or brake pedal when the ABS is operating. However, special tools are required, so please consult your Yamaha dealer.

ECA20100

NOTICE

Be careful not to damage the wheel sensor or wheel sensor rotor; otherwise, improper performance of the ABS will result.

Instrument and control functions

3

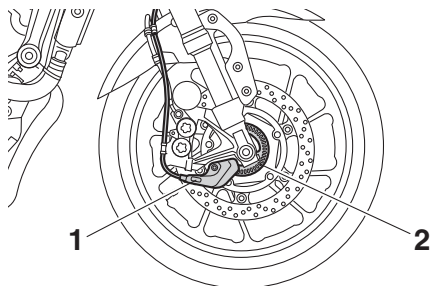

1. Front wheel sensor
2. Front wheel sensor rotor

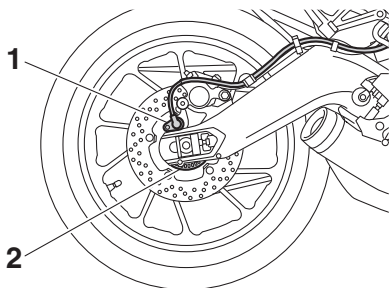

1. Rear wheel sensor
2. Rear wheel sensor rotor

EAU74351

Traction control system

The traction control system (TCS) helps maintain traction when accelerating on slippery surfaces, such as unpaved or wet roads. If sensors detect that the rear wheel is starting to slip (uncontrolled spinning), the traction control system assists by regulating engine power as needed until traction is restored.

EWA15433

WARNING

The traction control system is not a substitute for riding appropriately for the conditions. Traction control cannot prevent loss of traction due to excessive speed when entering turns, when accelerating hard at a sharp lean angle, or while braking, and cannot prevent front wheel slipping. As with any vehicle, approach surfaces that may be slippery with caution and avoid especially slippery surfaces.

The “TCS” indicator light flashes when traction control has engaged. You may notice slight changes in engine and ex-

haust sounds when the system has engaged.

In certain conditions, the traction control system may be automatically disabled. Should this happen, the “TCS” indicator light and the “” warning light will come on.

The TCS display (page 3-8) indicates the current TCS setting. There are three settings.

TCS “OFF”

TCS “OFF” turns the traction control system off.

TCS “1”

TCS “1” minimizes traction control system assist.

TCS “2”

TCS “2” maximizes traction control assist; wheel spin is most strongly controlled.

TIP

- Use the traction control switch (page 3-13) to change TCS settings.
- Traction control can be turned on

or off only when the vehicle is stopped.

- When the key is turned to “ON”, traction control is turned on and set to TCS “1” or “2” (whichever was last selected).
- Turn the traction control system off to help free the rear wheel if the vehicle gets stuck in mud, sand, or other soft surfaces.

ECA16801

NOTICE

Use only the specified tires. (See page 6-16.) Using different sized tires will prevent the traction control system from controlling tire rotation accurately.

Resetting the traction control system

The traction control system will automatically disable when:

- the front wheel or rear wheel comes off the ground while riding.
- excessive rear wheel spin is detected while riding.
- either wheel is rotated with the key turned to “ON” (such as when per-

forming maintenance).

If the traction control system is disabled, both the “TCS” indicator light and the “” warning light will come on. Should this occur, try resetting the system as follows.

1. Stop the vehicle and turn the key to “OFF”.
2. Wait a few seconds and then turn key back “ON”.
3. The “TCS” indicator light should turn off and the system be enabled.

TIP

If the “TCS” indicator light remains on after resetting, the vehicle may still be ridden; however, have a Yamaha dealer check the vehicle as soon as possible.

4. Have a Yamaha dealer check the vehicle and turn off the “” warning light.

Fuel tank cap

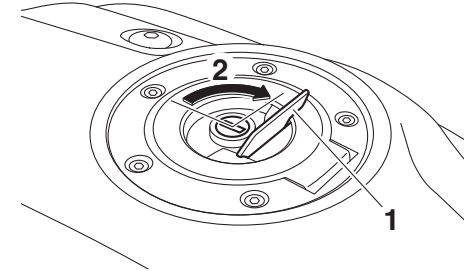

1. Fuel tank cap lock cover
2. Unlock.

To open the fuel tank cap

Open the fuel tank cap lock cover, insert the key into the lock, and then turn it 1/4 turn clockwise. The lock will be released and the fuel tank cap can be opened.

To close the fuel tank cap

With the key still inserted in the lock, push down the fuel tank cap. Turn the key 1/4 turn counterclockwise, remove it, and then close the lock cover.

TIP

The fuel tank cap cannot be closed un-

Instrument and control functions

less the key is in the lock. In addition, the key cannot be removed if the cap is not properly closed and locked.

EWA11092

WARNING

3 Make sure that the fuel tank cap is properly closed after filling fuel. Leaking fuel is a fire hazard.

Fuel

Make sure there is sufficient gasoline in the tank.

EAU13222

EWA10882

WARNING

Gasoline and gasoline vapors are extremely flammable. To avoid fires and explosions and to reduce the risk of injury when refueling, follow these instructions.

1. Before refueling, turn off the engine and be sure that no one is sitting on the vehicle. Never refuel while smoking, or while in the vicinity of sparks, open flames, or other sources of ignition such as the pilot lights of water heaters and clothes dryers.
2. Do not overfill the fuel tank. When refueling, be sure to insert the pump nozzle into the fuel tank filler hole. Stop filling when the fuel reaches the bottom of the filler tube. Because fuel expands when it heats up, heat from the engine or the sun can cause fuel to spill out of the fuel tank.

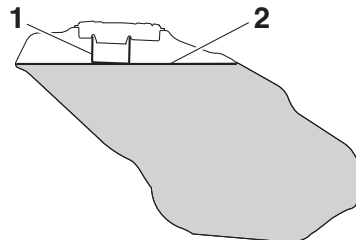

1. Fuel tank filler tube
2. Maximum fuel level
3. Wipe up any spilled fuel immediately. **NOTICE: Immediately wipe off spilled fuel with a clean, dry, soft cloth, since fuel may deteriorate painted surfaces or plastic parts.** [ECA10072]
4. Be sure to securely close the fuel tank cap.

EWA15152

WARNING

Gasoline is poisonous and can cause injury or death. Handle gasoline with care. Never siphon gasoline by mouth. If you should swallow some gasoline or inhale a lot of gasoline vapor, or get some gasoline in

your eyes, see your doctor immediately. If gasoline spills on your skin, wash with soap and water. If gasoline spills on your clothing, change your clothes.

EAU75300

Recommended fuel:

Premium unleaded gasoline (Gasohol [E10] acceptable)

Fuel tank capacity:

14 L (3.7 US gal, 3.1 Imp.gal)

Fuel reserve amount:

2.6 L (0.69 US gal, 0.57 Imp.gal)

ECA11401

NOTICE

Use only unleaded gasoline. The use of leaded gasoline will cause severe damage to internal engine parts, such as the valves and piston rings, as well as to the exhaust system.



TIP

- This mark identifies the recommended fuel for this vehicle as specified by European regulation (EN228).
- Check that gasoline nozzle has the same identifier when fueling.

Your Yamaha engine has been designed to use premium unleaded gasoline with a research octane number of 95 or higher. If knocking (or pinging) occurs, use a gasoline of a different brand. Use of unleaded fuel will extend spark plug life and reduce maintenance costs.

Gasohol

There are two types of gasohol: gaso-

hol containing ethanol and that containing methanol. Gasohol containing ethanol can be used if the ethanol content does not exceed 10% (E10). Gasohol containing methanol is not recommended by Yamaha because it can cause damage to the fuel system or vehicle performance problems.

Instrument and control functions

EAU51195

Fuel tank breather hose and overflow hose

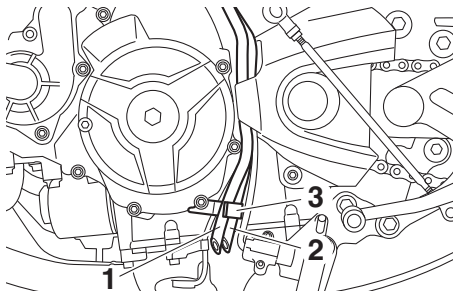

1. Fuel tank overflow hose
2. Canister breather hose
3. Clamp

Before operating the vehicle:

- check each hose connection.
- check each hose for damage. Replace if necessary.
- confirm the end of each hose is not blocked. Clean if necessary.
- confirm that each hose is routed through the clamp.

EAU13434

Catalytic converter

This model is equipped with a catalytic converter in the exhaust system.

EWA10863

WARNING

The exhaust system is hot after operation. To prevent a fire hazard or burns:

- Do not park the vehicle near possible fire hazards such as grass or other materials that easily burn.
- Park the vehicle in a place where pedestrians or children are not likely to touch the hot exhaust system.
- Make sure that the exhaust system has cooled down before doing any maintenance work.
- Do not allow the engine to idle more than a few minutes. Long idling can cause a build-up of heat.

ECA10702

NOTICE

Use only unleaded gasoline. The use of leaded gasoline will cause unre-

pairable damage to the catalytic converter.

EAU57991

Seat

To remove the seat

1. Open the seat lock cover, insert the key into the seat lock, and then turn the key counterclockwise.

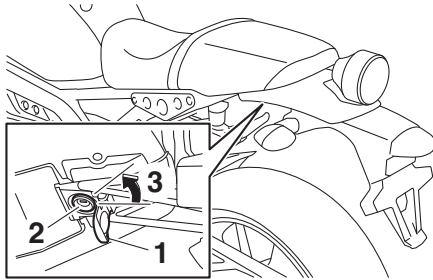

1. Seat lock cover
2. Seat lock
3. Unlock.

2. While holding the key in that position, lift the rear of the seat up, and then pull the seat off.

To install the seat

1. Insert the projections into the seat holders as shown.

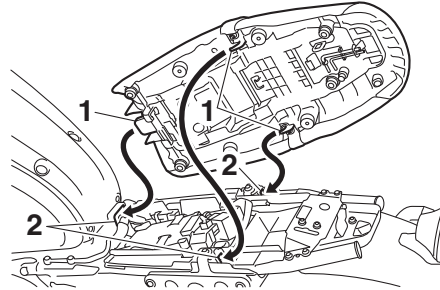

1. Projection
2. Seat holder

2. Push the rear of the seat down to lock it in place.
3. Remove the key.

TIP

Make sure that the seat is properly secured before riding.

EAU58200

Storage compartment

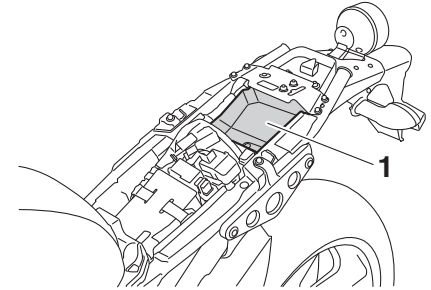

1. Storage compartment

The storage compartment is located under the seat. (See page 3-22.)

When storing documents or other items in the storage compartment, be sure to wrap them in a plastic bag so that they will not get wet. When washing the vehicle, be careful not to let any water enter the storage compartment.

EWA10962

WARNING

- Do not exceed the load limit of 3 kg (7 lb) for the storage compartment.
- Do not exceed the maximum load of 170 kg (375 lb) for the ve-

Instrument and control functions

hicle.

3

Adjusting the front fork

EAU62452

EWA14671

⚠ WARNING

Always adjust the spring preload on both fork legs equally, otherwise poor handling and loss of stability may result.

Each front fork leg is equipped with a spring preload adjusting bolt. The right front fork leg is equipped with a rebound damping force adjusting screw.

ECA10102

NOTICE

To avoid damaging the mechanism, do not attempt to turn beyond the maximum or minimum settings.

Spring preload

To increase the spring preload and thereby harden the suspension, turn the adjusting bolt on each fork leg in direction (a). To decrease the spring preload and thereby soften the suspension, turn the adjusting bolt on each fork leg in direction (b).

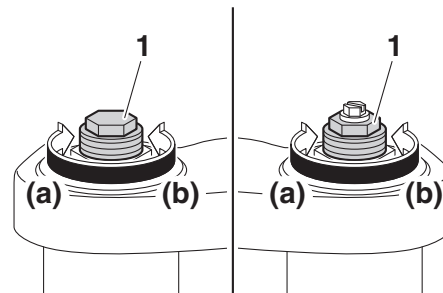

1. Spring preload adjusting bolt

The spring preload setting is determined by measuring distance A, shown in the illustration. The shorter distance A is, the higher the spring preload; the longer distance A is, the lower the spring preload.

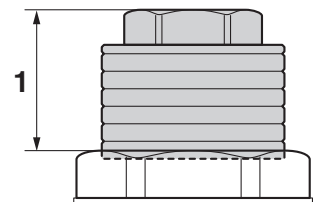

1. Distance A

Spring preload setting:

Minimum (soft):

Distance A = 19.0 mm (0.75 in)

Standard:

Distance A = 16.0 mm (0.63 in)

Maximum (hard):

Distance A = 4.0 mm (0.16 in)

Rebound damping setting:

Minimum (soft):

12 click(s) in direction (b)

Standard:

7 click(s) in direction (b)

Maximum (hard):

1 click(s) in direction (b)

Adjusting the shock absorber assembly

This shock absorber assembly is equipped with a spring preload adjusting ring and a rebound damping force adjusting screw.

3

ECA10102

Rebound damping force

The rebound damping force is adjusted on the right front fork leg only.

To increase the rebound damping force and thereby harden the rebound damping, turn the adjusting screw in direction (a). To decrease the rebound damping force and thereby soften the rebound damping, turn the adjusting screw in direction (b).

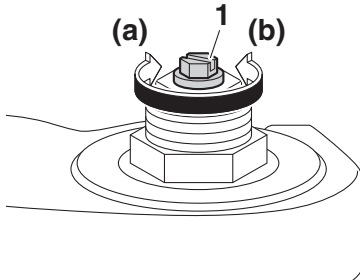

1. Rebound damping force adjusting screw

TIP

- When adjusting the damping force settings, turn the adjuster in direction (a) until it stops, and then count the turns or clicks in direction (b).
- Although a damping force adjuster may turn or click beyond the stated minimum settings, such adjustments are ineffective and may damage the suspension.
- When turning a damping force adjuster in direction (a), the 0 click position and the 1 click position may be the same.

NOTICE

To avoid damaging the mechanism, do not attempt to turn beyond the maximum or minimum settings.

Spring preload

To increase the spring preload and thereby harden the suspension, turn the adjusting ring in direction (a). To decrease the spring preload and thereby soften the suspension, turn the adjusting ring in direction (b).

Instrument and control functions

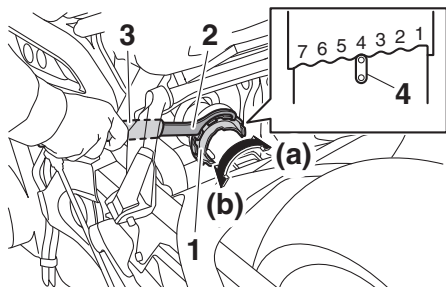

1. Spring preload adjusting ring
2. Special wrench
3. Extension bar
4. Position indicator

- Align the appropriate notch in the adjusting ring with the position indicator on the shock absorber.
- Use the special wrench and extension bar in the tool kit to make this adjustment.

Spring preload setting:

Minimum (soft):

1

Standard:

4

Maximum (hard):

7

Rebound damping force

To increase the rebound damping force and thereby harden the rebound damping, turn the adjusting screw in direction (a). To decrease the rebound damping force and thereby soften the rebound damping, turn the adjusting screw in direction (b).

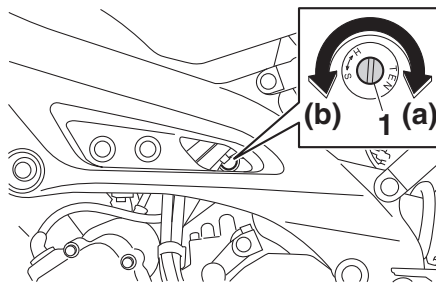

1. Rebound damping force adjusting screw

Rebound damping setting:

Minimum (soft):

3 turn(s) in direction (b)

Standard:

1-1/2 turn(s) in direction (b)

Maximum (hard):

0 turn(s) in direction (b)

TIP

- When adjusting the damping force

settings, turn the adjuster in direction (a) until it stops, and then count the turns in direction (b).

- Although a damping force adjuster may turn beyond the stated minimum settings, such adjustments are ineffective and may damage the suspension.

EWA10222

! WARNING

This shock absorber assembly contains highly pressurized nitrogen gas. Read and understand the following information before handling the shock absorber assembly.

- Do not tamper with or attempt to open the cylinder assembly.
- Do not subject the shock absorber assembly to an open flame or other high heat source. This may cause the unit to explode due to excessive gas pressure.
- Do not deform or damage the cylinder in any way. Cylinder damage will result in poor damping performance.
- Do not dispose of a damaged or

worn-out shock absorber assembly yourself. Take the shock absorber assembly to a Yamaha dealer for any service.

Luggage strap holders

EAU84680

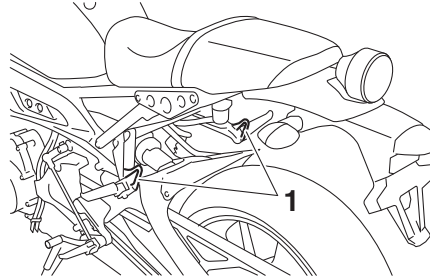

1. Luggage strap holder

Use the indicated strap points to secure luggage ties to the vehicle.

Auxiliary DC connector

EAU70641

This vehicle is equipped with an auxiliary DC connector. Consult your Yamaha dealer before installing any accessories.

Instrument and control functions

3

Sidestand

EAU15306

The sidestand is located on the left side of the frame. Raise the sidestand or lower it with your foot while holding the vehicle upright.

TIP

The built-in sidestand switch is part of the ignition circuit cut-off system, which cuts the ignition in certain situations. (See the following section for an explanation of the ignition circuit cut-off system.)

EWA10242

WARNING

The vehicle must not be ridden with the sidestand down, or if the sidestand cannot be properly moved up (or does not stay up), otherwise the sidestand could contact the ground and distract the operator, resulting in a possible loss of control. Yamaha's ignition circuit cut-off system has been designed to assist the operator in fulfilling the responsibility of raising the sidestand before starting off. Therefore, check this system regularly and have a

Yamaha dealer repair it if it does not function properly.

EAU44895

Ignition circuit cut-off system

This system prevents in-gear engine starts unless the clutch lever is pulled and the sidestand is up. Also, it will stop the running engine should the sidestand be lowered while the transmission is in gear.

Periodically check the system via the following procedure.

TIP

- This check is most reliable if performed with a warmed-up engine.
 - See pages 3-2 and 3-13 for switch operation information.
-

Instrument and control functions

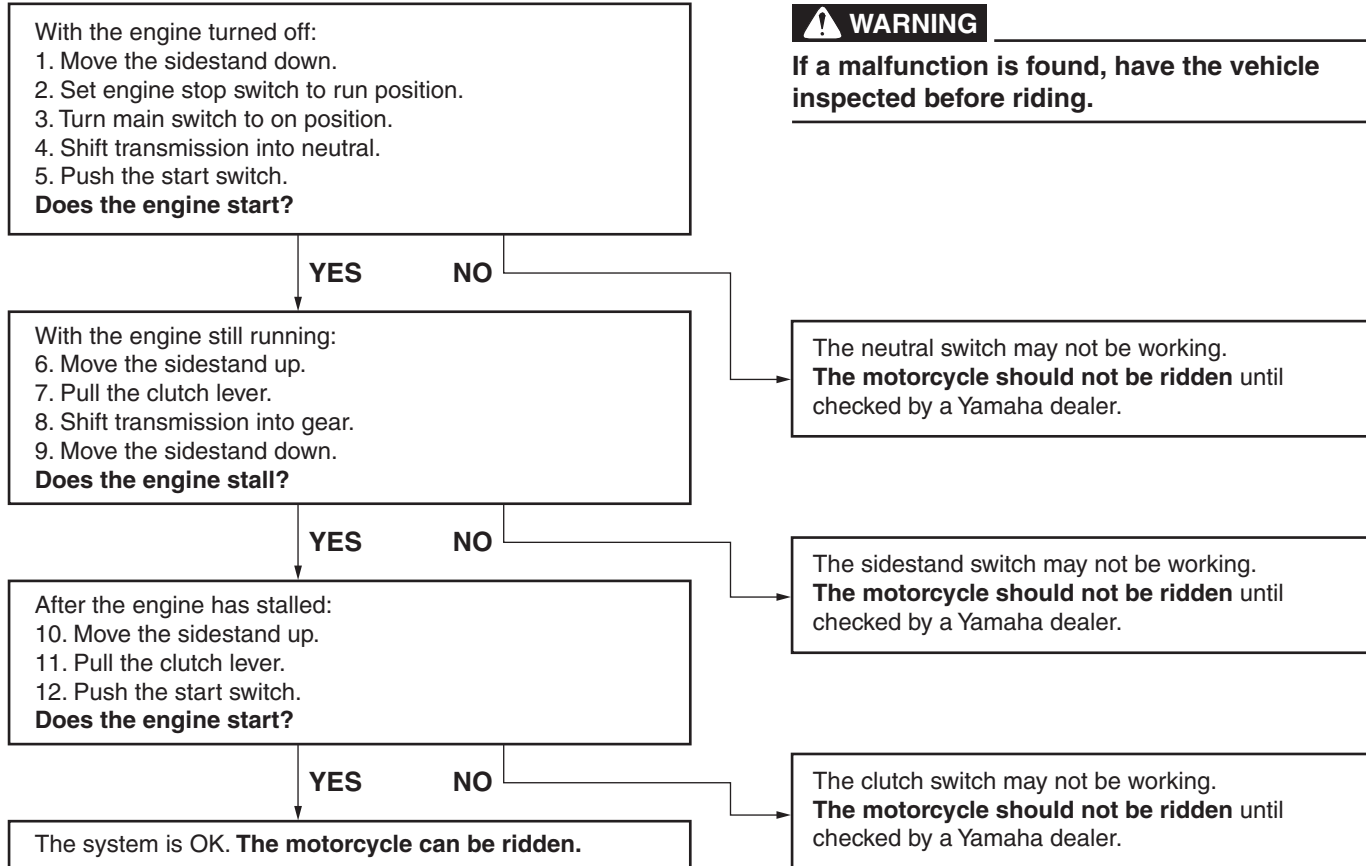

WARNING

If a malfunction is found, have the vehicle inspected before riding.

For your safety – pre-operation checks

EAU15599

Inspect your vehicle each time you use it to make sure the vehicle is in safe operating condition. Always follow the inspection and maintenance procedures and schedules described in the Owner's Manual.

EWA11152

WARNING

Failure to inspect or maintain the vehicle properly increases the possibility of an accident or equipment damage. Do not operate the vehicle if you find any problem. If a problem cannot be corrected by the procedures provided in this manual, have the vehicle inspected by a Yamaha dealer.

4

Before using this vehicle, check the following points:

ITEM	CHECKS	PAGE
Fuel	<ul style="list-style-type: none">• Check fuel level in fuel tank.• Refuel if necessary.• Check fuel line for leakage.• Check fuel tank breather hose and overflow hose for obstructions, cracks or damage, and check hose connections.	3-19, 3-21
Engine oil	<ul style="list-style-type: none">• Check oil level in engine.• If necessary, add recommended oil to specified level.• Check vehicle for oil leakage.	6-10
Coolant	<ul style="list-style-type: none">• Check coolant level in reservoir.• If necessary, add recommended coolant to specified level.• Check cooling system for leakage.	6-13
Front brake	<ul style="list-style-type: none">• Check operation.• If soft or spongy, have Yamaha dealer bleed hydraulic system.• Check brake pads for wear.• Replace if necessary.• Check fluid level in reservoir.• If necessary, add specified brake fluid to specified level.• Check hydraulic system for leakage.	6-20, 6-21

For your safety – pre-operation checks

ITEM	CHECKS	PAGE
Rear brake	<ul style="list-style-type: none"> • Check operation. • If soft or spongy, have Yamaha dealer bleed hydraulic system. • Check brake pads for wear. • Replace if necessary. • Check fluid level in reservoir. • If necessary, add specified brake fluid to specified level. • Check hydraulic system for leakage. 	6-20, 6-21
Clutch	<ul style="list-style-type: none"> • Check operation. • Lubricate cable if necessary. • Check lever free play. • Adjust if necessary. 	6-18
Throttle grip	<ul style="list-style-type: none"> • Make sure that operation is smooth. • Check throttle grip free play. • If necessary, have Yamaha dealer adjust throttle grip free play and lubricate cable and grip housing. 	6-15, 6-25
Control cables	<ul style="list-style-type: none"> • Make sure that operation is smooth. • Lubricate if necessary. 	6-25
Drive chain	<ul style="list-style-type: none"> • Check chain slack. • Adjust if necessary. • Check chain condition. • Lubricate if necessary. 	6-22, 6-24
Wheels and tires	<ul style="list-style-type: none"> • Check for damage. • Check tire condition and tread depth. • Check air pressure. • Correct if necessary. 	6-16, 6-18
Brake and shift pedals	<ul style="list-style-type: none"> • Make sure that operation is smooth. • Lubricate pedal pivoting points if necessary. 	6-25
Brake and clutch levers	<ul style="list-style-type: none"> • Make sure that operation is smooth. • Lubricate lever pivoting points if necessary. 	6-26
Sidestand	<ul style="list-style-type: none"> • Make sure that operation is smooth. • Lubricate pivot if necessary. 	6-27
Chassis fasteners	<ul style="list-style-type: none"> • Make sure that all nuts, bolts and screws are properly tightened. • Tighten if necessary. 	—

For your safety – pre-operation checks

ITEM	CHECKS	PAGE
Instruments, lights, signals and switches	<ul style="list-style-type: none">• Check operation.• Correct if necessary.	—
Sidestand switch	<ul style="list-style-type: none">• Check operation of ignition circuit cut-off system.• If system is not working correctly, have Yamaha dealer check vehicle.	3-27

Read the Owner's Manual carefully to become familiar with all controls. If there is a control or function you do not understand, ask your Yamaha dealer.

EWA10272

WARNING

Failure to familiarize yourself with the controls can lead to loss of control, which could cause an accident or injury.

TIP

This model is equipped with:

- a lean angle sensor. This sensor stops the engine in case of a vehicle turnover. If this happens, the engine trouble warning light will come on, but this is not a malfunction. Turn the vehicle power off and then back on again to cancel the warning light. Failing to do so will prevent the engine from starting even though the engine will crank when pushing the start switch.
- an engine auto-stop system. The engine stops automatically if left idling for 20 minutes. If the engine stops, simply push the start switch to restart the engine.

Starting the engine

In order for the ignition circuit cut-off system to enable starting, one of the following conditions must be met:

- The transmission is in the neutral position.
- The transmission is in gear with the clutch lever pulled and the sidestand up.

See page 3-27 for more information.

1. Turn the key to "ON" and make sure that the start/engine stop switch is set to "○".

The following warning lights and indicator light should come on for a few seconds, then go off.

- Oil level warning light
- Coolant temperature warning light
- Engine trouble warning light
- Immobilizer system indicator light

ECA17671

NOTICE

If the above warning lights or indicator light do not come on initially when the key is turned to "ON", or if

Operation and important riding points

a warning or indicator light remains on, see page 3-3 for the corresponding warning and indicator light circuit check.

The ABS warning light should come on when the key is turned to “ON”, and then go off after traveling at a speed of 10 km/h (6 mi/h) or higher.

ECA17682

5 NOTICE

If the ABS warning light does not come on and then go off as explained above, see page 3-3 for the warning light circuit check.

2. Shift the transmission into the neutral position. The neutral indicator light should come on. If not, ask a Yamaha dealer to check the electrical circuit.
3. Start the engine by sliding the switch toward “”.

If the engine fails to start, release the start/engine stop switch, wait a few seconds, and then try again. Each starting attempt should be as short as possible to preserve the battery. Do not crank the engine

more than 10 seconds on any one attempt.

ECA11043

NOTICE

For maximum engine life, never accelerate hard when the engine is cold!

Shifting

EAU16674

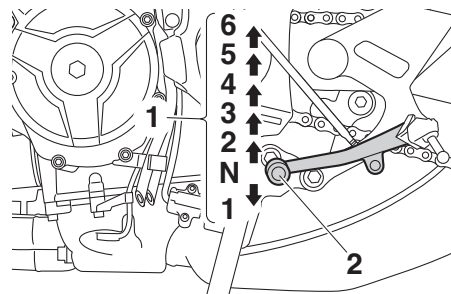

1. Gear positions
2. Shift pedal

Shifting gears lets you control the amount of engine power available for starting off, accelerating, climbing hills, etc.

The gear positions are shown in the illustration.

TIP

To shift the transmission into the neutral position (N), press the shift pedal down repeatedly until it reaches the end of its travel, and then slightly raise it.

NOTICE

- Even with the transmission in the neutral position, do not coast for long periods of time with the engine off, and do not tow the motorcycle for long distances. The transmission is properly lubricated only when the engine is running. Inadequate lubrication may damage the transmission.
- Always use the clutch while changing gears to avoid damaging the engine, transmission, and drive train, which are not designed to withstand the shock of forced shifting.

Tips for reducing fuel consumption

Fuel consumption depends largely on your riding style. Consider the following tips to reduce fuel consumption:

- Shift up swiftly, and avoid high engine speeds during acceleration.
- Do not rev the engine while shifting down, and avoid high engine speeds with no load on the engine.
- Turn the engine off instead of letting it idle for an extended length of time (e.g., in traffic jams, at traffic lights or at railroad crossings).

Engine break-in

There is never a more important period in the life of your engine than the period between 0 and 1600 km (1000 mi). For this reason, you should read the following material carefully.

Since the engine is brand new, do not put an excessive load on it for the first 1600 km (1000 mi). The various parts in the engine wear and polish themselves to the correct operating clearances. During this period, prolonged full-throttle operation or any condition that might result in engine overheating must be avoided.

0–1000 km (0–600 mi)

Avoid prolonged operation above 5600 r/min. **NOTICE: After 1000 km (600 mi) of operation, the engine oil must be changed and the oil filter cartridge or element replaced.**^[ECA10303]

1000–1600 km (600–1000 mi)

Avoid prolonged operation above 6800

Operation and important riding points

r/min.

1600 km (1000 mi) and beyond

The vehicle can now be operated normally.

ECA10311

NOTICE

- Keep the engine speed out of the tachometer red zone.
- If any engine trouble should occur during the engine break-in period, immediately have a Yamaha dealer check the vehicle.

EAU17214

Parking

When parking, stop the engine, and then remove the key from the main switch.

EWA10312

WARNING

- Since the engine and exhaust system can become very hot, park in a place where pedestrians or children are not likely to touch them and be burned.
- Do not park on a slope or on soft ground, otherwise the vehicle may overturn, increasing the risk of a fuel leak and fire.
- Do not park near grass or other flammable materials which might catch fire.

EAU17246

EWA15123

EAU17303

Periodic inspection, adjustment, and lubrication will keep your vehicle in the safest and most efficient condition possible. Safety is an obligation of the vehicle owner/operator. The most important points of vehicle inspection, adjustment, and lubrication are explained on the following pages.

The intervals given in the periodic maintenance charts should be simply considered as a general guide under normal riding conditions. However, depending on the weather, terrain, geographical location, and individual use, the maintenance intervals may need to be shortened.

WARNING

EWA10322

Failure to properly maintain the vehicle or performing maintenance activities incorrectly may increase your risk of injury or death during service or while using the vehicle. If you are not familiar with vehicle service, have a Yamaha dealer perform service.

WARNING

Turn off the engine when performing maintenance unless otherwise specified.

- **A running engine has moving parts that can catch on body parts or clothing and electrical parts that can cause shocks or fires.**
- **Running the engine while servicing can lead to eye injury, burns, fire, or carbon monoxide poisoning – possibly leading to death. See page 1-2 for more information about carbon monoxide.**

EWA15461

WARNING

Brake discs, calipers, drums, and linings can become very hot during use. To avoid possible burns, let brake components cool before touching them.

Emission controls not only function to ensure cleaner air, but are also vital to proper engine operation and maximum performance. In the following periodic maintenance charts, the services related to emissions control are grouped separately. These services require specialized data, knowledge, and equipment. Maintenance, replacement, or repair of the emission control devices and systems may be performed by any repair establishment or individual that is certified (if applicable). Yamaha dealers are trained and equipped to perform these particular services.

Periodic maintenance and adjustment

EAU85230

Tool kit

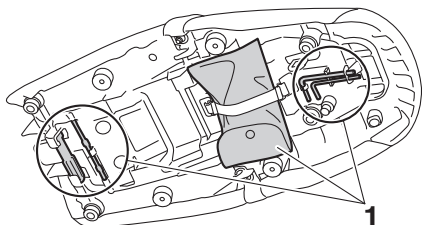

1. Tool kit

6

The tool kit is in the location shown.

The information included in this manual and the tools provided in the tool kit are intended to assist you in the performance of preventive maintenance and minor repairs. However, a torque wrench and other tools are necessary to perform certain maintenance work correctly.

TIP

If you do not have the tools or experience required for a particular job, have your Yamaha dealer perform it for you.

Periodic maintenance and adjustment

EAU71033

Periodic maintenance charts

TIP

- Items marked with an asterisk should be performed by your Yamaha dealer because these items require special tools, data, and technical skills.
- From 50000 km (30000 mi), repeat the maintenance intervals starting from 10000 km (6000 mi).
- **The annual checks must be performed every year, except if a distance-based maintenance is performed instead.**

EAU71051

Periodic maintenance chart for the emission control system

NO.	ITEM	CHECK OR MAINTENANCE JOB	ODOMETER READING					ANNUAL CHECK
			1000 km (600 mi)	10000 km (6000 mi)	20000 km (12000 mi)	30000 km (18000 mi)	40000 km (24000 mi)	
1	* Fuel line	<ul style="list-style-type: none"> • Check fuel hoses for cracks or damage. • Replace if necessary. 		√	√	√	√	√
2	* Spark plugs	<ul style="list-style-type: none"> • Check condition. • Adjust gap and clean. 		√		√		
		<ul style="list-style-type: none"> • Replace. 			√		√	
3	* Valve clearance	<ul style="list-style-type: none"> • Check and adjust. 	Every 40000 km (24000 mi)					
4	* Fuel injection	<ul style="list-style-type: none"> • Check engine idle speed. 	√	√	√	√	√	√
		<ul style="list-style-type: none"> • Check and adjust synchronization. 		√	√	√	√	√
5	* Exhaust system	<ul style="list-style-type: none"> • Check for leakage. • Tighten if necessary. • Replace gaskets if necessary. 	√	√	√	√	√	
6	* Evaporative emission control system	<ul style="list-style-type: none"> • Check control system for damage. • Replace if necessary. 			√		√	

Periodic maintenance and adjustment

NO.	ITEM	CHECK OR MAINTENANCE JOB	ODOMETER READING					ANNUAL CHECK
			1000 km (600 mi)	10000 km (6000 mi)	20000 km (12000 mi)	30000 km (18000 mi)	40000 km (24000 mi)	
7	* Air induction system	<ul style="list-style-type: none"> • Check the air cut-off valve, reed valve, and hose for damage. • Replace any damaged parts if necessary. 		√	√	√	√	√

Periodic maintenance and adjustment

EAU71352

General maintenance and lubrication chart

NO.	ITEM	CHECK OR MAINTENANCE JOB	ODOMETER READING					ANNUAL CHECK
			1000 km (600 mi)	10000 km (6000 mi)	20000 km (12000 mi)	30000 km (18000 mi)	40000 km (24000 mi)	
1	* Diagnostic system check	<ul style="list-style-type: none"> Perform dynamic inspection using Yamaha diagnostic tool. Check the error codes. 	√	√	√	√	√	√
2	* Air filter element	<ul style="list-style-type: none"> Replace. 	Every 40000 km (24000 mi)					
3	Clutch	<ul style="list-style-type: none"> Check operation. Adjust. 	√	√	√	√	√	
4	* Front brake	<ul style="list-style-type: none"> Check operation, fluid level, and for fluid leakage. Replace brake pads if necessary. 	√	√	√	√	√	√
5	* Rear brake	<ul style="list-style-type: none"> Check operation, fluid level, and for fluid leakage. Replace brake pads if necessary. 	√	√	√	√	√	√
6	* Brake hoses	<ul style="list-style-type: none"> Check for cracks or damage. 		√	√	√	√	√
		<ul style="list-style-type: none"> Replace. 	Every 4 years					
7	* Brake fluid	<ul style="list-style-type: none"> Change. 	Every 2 years					
8	* Wheels	<ul style="list-style-type: none"> Check runout and for damage. Replace if necessary. 		√	√	√	√	
9	* Tires	<ul style="list-style-type: none"> Check tread depth and for damage. Replace if necessary. Check air pressure. Correct if necessary. 		√	√	√	√	√
10	* Wheel bearings	<ul style="list-style-type: none"> Check bearing for looseness or damage. 		√	√	√	√	
11	* Swingarm pivot bearings	<ul style="list-style-type: none"> Check operation and for excessive play. 		√	√	√	√	

Periodic maintenance and adjustment

NO.	ITEM	CHECK OR MAINTENANCE JOB	ODOMETER READING					ANNUAL CHECK
			1000 km (600 mi)	10000 km (6000 mi)	20000 km (12000 mi)	30000 km (18000 mi)	40000 km (24000 mi)	
12	Drive chain	<ul style="list-style-type: none"> • Check chain slack, alignment and condition. • Adjust and lubricate chain with a special O-ring chain lubricant thoroughly. 	Every 1000 km (600 mi) and after washing the motorcycle, riding in the rain or riding in wet areas					
13	* Steering bearings	<ul style="list-style-type: none"> • Check bearing assemblies for looseness. 	√	√		√		
		<ul style="list-style-type: none"> • Moderately repack with lithium-soap-based grease. 			√		√	
14	* Chassis fasteners	<ul style="list-style-type: none"> • Make sure that all nuts, bolts and screws are properly tightened. 		√	√	√	√	√
15	Brake lever pivot shaft	<ul style="list-style-type: none"> • Lubricate with silicone grease. 		√	√	√	√	√
16	Brake pedal pivot shaft	<ul style="list-style-type: none"> • Lubricate with lithium-soap-based grease. 		√	√	√	√	√
17	Clutch lever pivot shaft	<ul style="list-style-type: none"> • Lubricate with lithium-soap-based grease. 		√	√	√	√	√
18	Shift pedal pivot shaft	<ul style="list-style-type: none"> • Lubricate with lithium-soap-based grease. 		√	√	√	√	√
19	Sidestand	<ul style="list-style-type: none"> • Check operation. • Lubricate with lithium-soap-based grease. 		√	√	√	√	√
20	* Sidestand switch	<ul style="list-style-type: none"> • Check operation and replace if necessary. 	√	√	√	√	√	√
21	* Front fork	<ul style="list-style-type: none"> • Check operation and for oil leakage. • Replace if necessary. 		√	√	√	√	
22	* Shock absorber assembly	<ul style="list-style-type: none"> • Check operation and for oil leakage. • Replace if necessary. 		√	√	√	√	

Periodic maintenance and adjustment

NO.	ITEM	CHECK OR MAINTENANCE JOB	ODOMETER READING					ANNUAL CHECK
			1000 km (600 mi)	10000 km (6000 mi)	20000 km (12000 mi)	30000 km (18000 mi)	40000 km (24000 mi)	
23	* Rear suspension relay arm and connecting arm pivoting points	<ul style="list-style-type: none"> • Check operation. 		√	√	√	√	
24	Engine oil	<ul style="list-style-type: none"> • Change (warm engine before draining). • Check oil level and vehicle for oil leakage. 	√	√	√	√	√	√
25	Engine oil filter cartridge	<ul style="list-style-type: none"> • Replace. 	√		√		√	
26	* Cooling system	<ul style="list-style-type: none"> • Check coolant level and vehicle for coolant leakage. 		√	√	√	√	√
		<ul style="list-style-type: none"> • Change. 	Every 3 years					
27	* Front and rear brake switches	<ul style="list-style-type: none"> • Check operation. 	√	√	√	√	√	√
28	* Moving parts and cables	<ul style="list-style-type: none"> • Lubricate. 		√	√	√	√	√
29	* Throttle grip housing and cable	<ul style="list-style-type: none"> • Check operation and free play. • Adjust the throttle cable free play if necessary. • Lubricate the throttle grip housing and cable. 		√	√	√	√	√
30	* Lights, signals and switches	<ul style="list-style-type: none"> • Check operation. • Adjust headlight beam. 	√	√	√	√	√	√

Periodic maintenance and adjustment

EAU72800

TIP

- Air filter
 - This model's air filter is equipped with a disposable oil-coated paper element, which must not be cleaned with compressed air to avoid damaging it.
 - The air filter element needs to be replaced more frequently when riding in unusually wet or dusty areas.
 - Hydraulic brake service
 - Regularly check and, if necessary, correct the brake fluid level.
 - Every two years replace the internal components of the brake master cylinders and calipers, and change the brake fluid.
 - Replace the brake hoses every four years and if cracked or damaged.
-

Periodic maintenance and adjustment

EAU19653

Checking the spark plugs

The spark plugs are important engine components, which should be checked periodically, preferably by a Yamaha dealer. Since heat and deposits will cause any spark plug to slowly erode, they should be removed and checked in accordance with the periodic maintenance and lubrication chart. In addition, the condition of the spark plugs can reveal the condition of the engine.

The porcelain insulator around the center electrode of each spark plug should be a medium-to-light tan (the ideal color when the vehicle is ridden normally), and all spark plugs installed in the engine should have the same color. If any spark plug shows a distinctly different color, the engine could be operating improperly. Do not attempt to diagnose such problems yourself. Instead, have a Yamaha dealer check the vehicle.

If a spark plug shows signs of electrode erosion and excessive carbon or other deposits, it should be replaced.

Specified spark plug:
NGK/CPR9EA9

Before installing a spark plug, the spark plug gap should be measured with a wire thickness gauge and, if necessary, adjusted to specification.

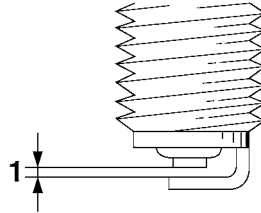

1. Spark plug gap

Spark plug gap:
0.8–0.9 mm (0.031–0.035 in)

Clean the surface of the spark plug gasket and its mating surface, and then wipe off any grime from the spark plug threads.

Tightening torque:
Spark plug:
13 N·m (1.3 kgf·m, 9.6 lb·ft)

TIP _____
If a torque wrench is not available when

installing a spark plug, a good estimate of the correct torque is 1/4–1/2 turn past finger tight. However, the spark plug should be tightened to the specified torque as soon as possible.

ECA10841

NOTICE

Do not use any tools to remove or install the spark plug cap, otherwise the ignition coil coupler may get damaged. The spark plug cap may be difficult to remove because the rubber seal on the end of the cap fits tightly. To remove the spark plug cap, simply twist it back and forth while pulling it out; to install it, twist it back and forth while pushing it in.

Periodic maintenance and adjustment

Canister

EAU36112

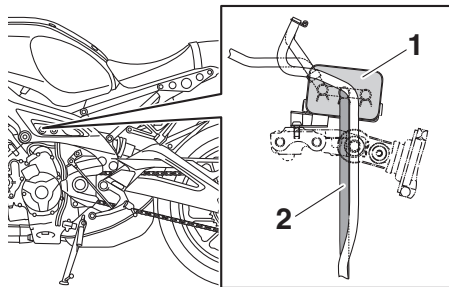

1. Canister
2. Canister breather hose

This model is equipped with a canister to prevent the discharging of fuel vapor into the atmosphere. Before operating this vehicle, make sure to check the following:

- Check each hose connection.
- Check each hose and canister for cracks or damage. Replace if damaged.
- Make sure that the canister breather is not blocked, and if necessary, clean it.

Engine oil

EAU1990F

The engine oil level should be checked regularly. In addition, the oil must be changed and the oil filter cartridge replaced at the intervals specified in the periodic maintenance chart.

Recommended engine oil:

See page 8-1.

Oil quantity:

Oil change:

2.40 L (2.54 US qt, 2.11 Imp.qt)

With oil filter removal:

2.70 L (2.85 US qt, 2.38 Imp.qt)

ECA11621

NOTICE

- **In order to prevent clutch slippage (since the engine oil also lubricates the clutch), do not mix any chemical additives. Do not use oils with a diesel specification of “CD” or oils of a higher quality than specified. In addition, do not use oils labeled “ENERGY CONSERVING II” or higher.**
- **Make sure that no foreign material enters the crankcase.**

To check the engine oil level

1. After warming up the engine, wait a few minutes for the oil level to settle for an accurate reading.
2. With the vehicle on a level surface, hold it upright for an accurate reading.
3. Look at the check window located at the bottom-right side of the crankcase.

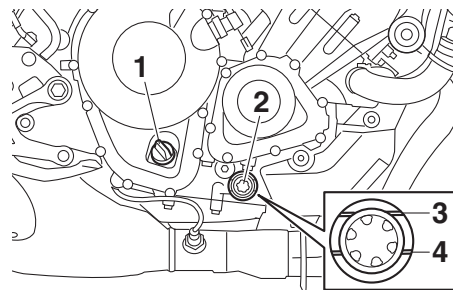

1. Engine oil filler cap
2. Engine oil level check window
3. Maximum level mark
4. Minimum level mark

TIP

The engine oil should be between the minimum and maximum level marks.

4. If the engine oil is at or below the

Periodic maintenance and adjustment

minimum level mark, remove the oil filler cap and add oil.

5. Check the engine oil filler cap O-ring. Replace if damaged.

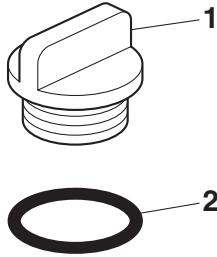

1. Engine oil filler cap
2. O-ring

6. Install the engine oil filler cap.

To change the engine oil (and filter)

1. Start the engine and allow it to idle for a few minutes to warm up the oil, and then stop the engine.
2. Place an oil pan under the engine to collect the used oil.
3. Remove the engine oil filler cap, and then the engine oil drain bolt and gasket.

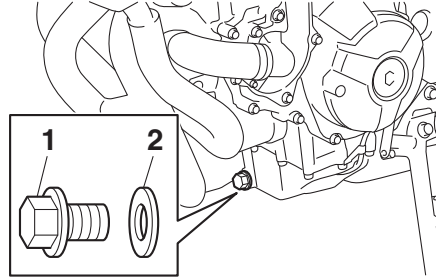

1. Engine oil drain bolt
2. Gasket

TIP

Skip steps 4–6 if the oil filter cartridge is not being replaced.

4. Remove the oil filter cartridge with an oil filter wrench.

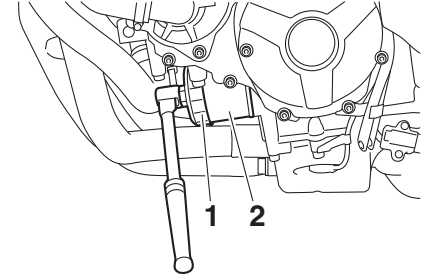

1. Oil filter wrench
2. Oil filter cartridge

TIP

An oil filter wrench is available at a Yamaha dealer.

5. Apply a thin coat of clean engine oil to the O-ring of the new oil filter cartridge.

Periodic maintenance and adjustment

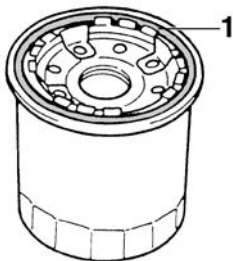

1. O-ring

TIP _____
Make sure that the O-ring is properly seated.

6. Install the new oil filter cartridge, and then tighten to the specified torque.

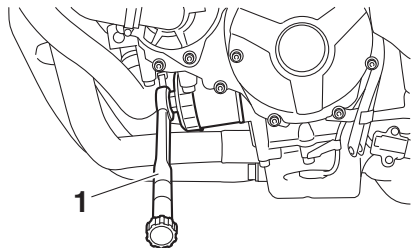

1. Torque wrench

Tightening torque:

Oil filter cartridge:
17 N·m (1.7 kgf·m, 13 lb-ft)

7. Install the engine oil drain bolt with a new gasket, and then tighten the bolt to the specified torque.

Tightening torque:

Engine oil drain bolt:
43 N·m (4.3 kgf·m, 32 lb-ft)

8. Pour the specified amount of the recommended oil into the crankcase.

TIP _____
Using a funnel is recommended.

9. After checking the engine oil filler cap O-ring, install the filler cap.

TIP _____
Wipe off any spilled oil before starting the engine.

10. Start the engine and let it idle while checking for oil leaks.

TIP _____
If any oil leaks are found which you cannot fix, have the vehicle inspected.

11. Stop the engine, wait a few minutes for the oil to settle, and then check the oil level one last time.
NOTICE: Do not operate the vehicle until you know that the engine oil level is sufficient.^[ECA10012]

EAU85450

EAUS1203

Why Yamalube

YAMALUBE oil is a Genuine YAMAHA Part born of the engineers' passion and belief that engine oil is an important liquid engine component. We form teams of specialists in the fields of mechanical engineering, chemistry, electronics and track testing, and have them develop the engine together with the oil it will use. Yamalube oils take full advantage of the base oil's qualities and blend in the ideal balance of additives to make sure the final oil clears our performance standards. Thus, Yamalube mineral, semisynthetic and synthetic oils have their own distinct characters and value. Yamaha's experience gained over many years of research and development into oil since the 1960's helps make Yamalube the best choice for your Yamaha engine.



Coolant

The coolant level should be checked regularly. In addition, the coolant must be changed at the intervals specified in the periodic maintenance chart.

Recommended coolant:

YAMALUBE coolant

Coolant quantity:

Coolant reservoir (max level mark):
0.25 L (0.26 US qt, 0.22 Imp.qt)

Radiator (including all routes):
1.93 L (2.04 US qt, 1.70 Imp.qt)

TIP

If genuine Yamaha coolant is not available, use an ethylene glycol antifreeze containing corrosion inhibitors for aluminum engines and mix with distilled water at a 1:1 ratio.

EAU20097

To check the coolant level

Since the coolant level varies with engine temperature, check when the engine is cold.

1. Park the vehicle on a level surface.
2. With the vehicle in an upright position, look at the coolant level in the

reservoir.

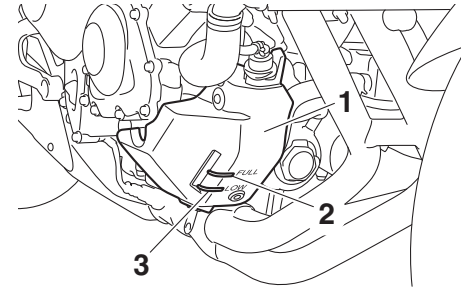

1. Coolant reservoir
2. Maximum level mark
3. Minimum level mark

3. If the coolant is at or below the minimum level mark, remove the coolant reservoir cap. **WARNING! Remove only the coolant reservoir cap. Never attempt to remove the radiator cap when the engine is hot.**^[EWA15162]

Periodic maintenance and adjustment

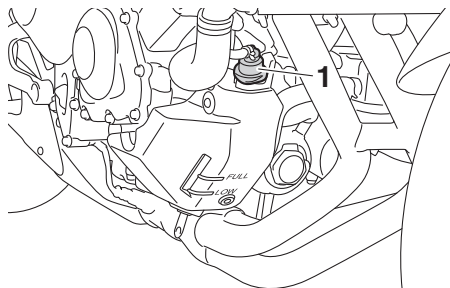

1. Coolant reservoir cap

4. Add coolant to the maximum level mark. **NOTICE:** If coolant is not available, use distilled water or soft tap water instead. Do not use hard water or salt water since it is harmful to the engine. If water has been used instead of coolant, replace it with coolant as soon as possible, otherwise the cooling system will not be protected against frost and corrosion. If water has been added to the coolant, have a Yamaha dealer check the anti-freeze content of the coolant as soon as possible, otherwise the effectiveness of the coolant will

be reduced.^[ECA10473]

5. Install the coolant reservoir cap.

EAU33032

Changing the coolant

The coolant must be changed at the intervals specified in the periodic maintenance and lubrication chart. Have a Yamaha dealer change the coolant.

WARNING! Never attempt to remove the radiator cap when the engine is hot.^[EWA10382]

EAU36765

Air filter element

The air filter element must be replaced at the intervals specified in the periodic maintenance and lubrication chart. Have a Yamaha dealer replace the air filter element.

EAU44735

Checking the engine idling speed

Check the engine idling speed and, if necessary, have it corrected by a Yamaha dealer.

Engine idling speed:
1100–1300 r/min

EAU21386

Checking the throttle grip free play

Measure the throttle grip free play as shown.

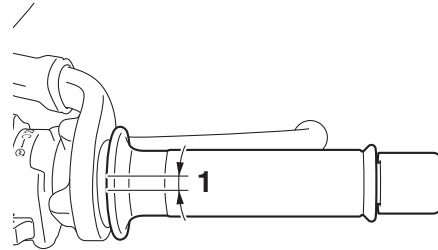

1. Throttle grip free play

Throttle grip free play:
3.0–5.0 mm (0.12–0.20 in)

Periodically check the throttle grip free play and, if necessary, have a Yamaha dealer adjust it.

EAU21403

Valve clearance

The valves are an important engine component, and since valve clearance changes with use, they must be checked and adjusted at the intervals specified in the periodic maintenance chart. Unadjusted valves can result in improper air-fuel mixture, engine noise, and eventually engine damage. To prevent this from occurring, have your Yamaha dealer check and adjust the valve clearance at regular intervals.

TIP

This service must be performed when the engine is cold.

Periodic maintenance and adjustment

EAU64412

Tires

Tires are the only contact between the vehicle and the road. Safety in all conditions of riding depends on a relatively small area of road contact. Therefore, it is essential to maintain the tires in good condition at all times and replace them at the appropriate time with the specified tires.

Tire air pressure

The tire air pressure should be checked and, if necessary, adjusted before each ride.

EWA10504

⚠ WARNING

Operation of this vehicle with improper tire pressure may cause severe injury or death from loss of control.

- The tire air pressure must be checked and adjusted on cold tires (i.e., when the temperature of the tires equals the ambient temperature).
- The tire air pressure must be adjusted in accordance with the riding speed and with the total

weight of rider, passenger, cargo, and accessories approved for this model.

Cold tire air pressure:

1 person:

Front:

250 kPa (2.50 kgf/cm², 36 psi)

Rear:

290 kPa (2.90 kgf/cm², 42 psi)

2 persons:

Front:

250 kPa (2.50 kgf/cm², 36 psi)

Rear:

290 kPa (2.90 kgf/cm², 42 psi)

Maximum load:

Vehicle:

170 kg (375 lb)

The vehicle's maximum load is the combined weight of the rider, passenger, cargo, and any accessories.

EWA10512

⚠ WARNING

Never overload your vehicle. Operation of an overloaded vehicle could cause an accident.

Tire inspection

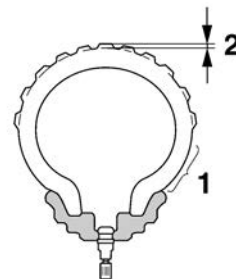

1. Tire sidewall
2. Tire tread depth

The tires must be checked before each ride. If the center tread depth reaches the specified limit, if the tire has a nail or glass fragments in it, or if the sidewall is cracked, have a Yamaha dealer replace the tire immediately.

Minimum tire tread depth (front and rear):

1.6 mm (0.06 in)

TIP

The tire tread depth limits may differ from country to country. Always comply with the local regulations.

Periodic maintenance and adjustment

EWA10472

WARNING

- Have a Yamaha dealer replace excessively worn tires. Besides being illegal, operating the vehicle with excessively worn tires decreases riding stability and can lead to loss of control.
- The replacement of all wheel and brake-related parts, including the tires, should be left to a Yamaha dealer, who has the necessary professional knowledge and experience to do so.
- Ride at moderate speeds after changing a tire since the tire surface must first be “broken in” for it to develop its optimal characteristics.

Tire information

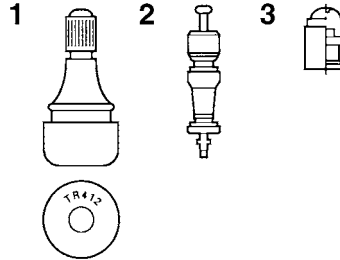

1. Tire air valve
2. Tire air valve core
3. Tire air valve cap with seal

This model is equipped with tubeless tires and tire air valves.

Tires age, even if they have not been used or have only been used occasionally. Cracking of the tread and sidewall rubber, sometimes accompanied by carcass deformation, is an evidence of ageing. Old and aged tires shall be checked by tire specialists to ascertain their suitability for further use.

EWA10902

WARNING

- The front and rear tires should be of the same make and de-

sign, otherwise the handling characteristics of the motorcycle may be different, which could lead to an accident.

- Always make sure that the valve caps are securely installed to prevent air pressure leakage.
- Use only the tire valves and valve cores listed below to avoid tire deflation during a ride.

After extensive tests, only the tires listed below have been approved for this model by Yamaha.

Front tire:

Size:

120/70 ZR17M/C(58W)

Manufacturer/model:

BRIDGESTONE/S20F M

Rear tire:

Size:

180/55 ZR17M/C (73W)

Manufacturer/model:

BRIDGESTONE/S20R M

FRONT and REAR:

Tire air valve:

TR412

Valve core:

#9100 (original)

Periodic maintenance and adjustment

EWA10601

EAU21963

EAU22083

⚠ WARNING

This motorcycle is fitted with super-high-speed tires. Note the following points in order to make the most efficient use of these tires.

- Use only the specified replacement tires. Other tires may run the danger of bursting at super high speeds.
- Brand-new tires can have a relatively poor grip on certain road surfaces until they have been “broken in”. Therefore, it is advisable before doing any high-speed riding to ride conservatively for approximately 100 km (60 mi) after installing a new tire.
- The tires must be warmed up before a high-speed run.
- Always adjust the tire air pressure according to the operating conditions.

Cast wheels

To maximize the performance, durability, and safe operation of your vehicle, note the following points regarding the specified wheels.

- The wheel rims should be checked for cracks, bends, warpage or other damage before each ride. If any damage is found, have a Yamaha dealer replace the wheel. Do not attempt even the smallest repair to the wheel. A deformed or cracked wheel must be replaced.
- The wheel should be balanced whenever either the tire or wheel has been changed or replaced. An unbalanced wheel can result in poor performance, adverse handling characteristics, and a shortened tire life.

Adjusting the clutch lever free play

Measure the clutch lever free play as shown.

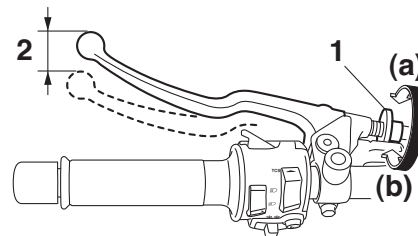

1. Clutch lever free play adjusting bolt
2. Clutch lever free play

Clutch lever free play:
10.0–15.0 mm (0.39–0.59 in)

Periodically check the clutch lever free play and, if necessary, adjust it as follows.

To increase the clutch lever free play, turn the clutch lever free play adjusting bolt in direction (a). To decrease the clutch lever free play, turn the adjusting bolt in direction (b).

Periodic maintenance and adjustment

TIP

If the specified free play cannot be obtained as described above or if the clutch does not operate correctly, have a Yamaha dealer check the internal clutch mechanism.

Checking the brake lever free play

EAU37914

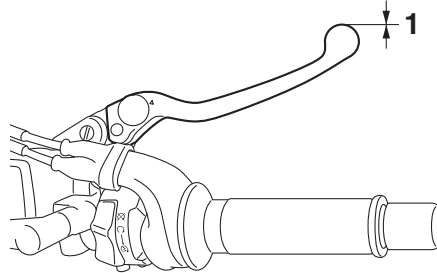

1. No brake lever free play

There should be no free play at the brake lever end. If there is free play, have a Yamaha dealer inspect the brake system.

EWA14212

WARNING

A soft or spongy feeling in the brake lever can indicate the presence of air in the hydraulic system. If there is air in the hydraulic system, have a Yamaha dealer bleed the system before operating the vehicle. Air in the hydraulic system will diminish the braking performance, which may re-

sult in loss of control and an accident.

Periodic maintenance and adjustment

Brake light switches

The brake light should come on just before braking takes effect. The brake light is activated by switches connected to the brake lever and brake pedal. Since the brake light switches are components of the anti-lock brake system, they should only be serviced by a Yamaha dealer.

EAU36505

Checking the front and rear brake pads

The front and rear brake pads must be checked for wear at the intervals specified in the periodic maintenance and lubrication chart.

EAU22393

Front brake pads

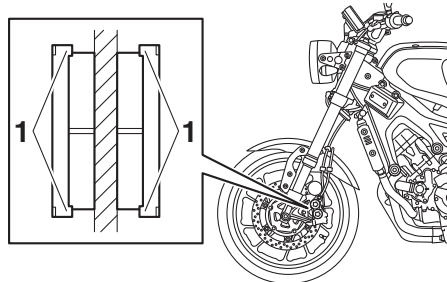

EAU36891

1. Brake pad wear indicator

Each front brake pad is provided with wear indicators, which allows you to check the brake pad wear without having to disassemble the brake. To check the brake pad wear, check the position of the wear indicators while applying the brake. If a brake pad has worn to the point that a wear indicator almost

touches the brake disc, have a Yamaha dealer replace the brake pads as a set.

Rear brake pads

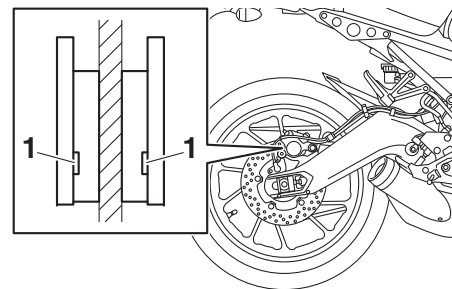

EAU46292

1. Brake pad wear indicator groove

Each rear brake pad is provided with wear indicator grooves, which allow you to check the brake pad wear without having to disassemble the brake. To check the brake pad wear, check the wear indicator grooves. If a brake pad has worn to the point that a wear indicator groove almost appears, have a Yamaha dealer replace the brake pads as a set.

Periodic maintenance and adjustment

EAU40262

Checking the brake fluid level

Before riding, check that the brake fluid is above the minimum level mark. Check the brake fluid level with the top of the reservoir level. Replenish the brake fluid if necessary.

Front brake

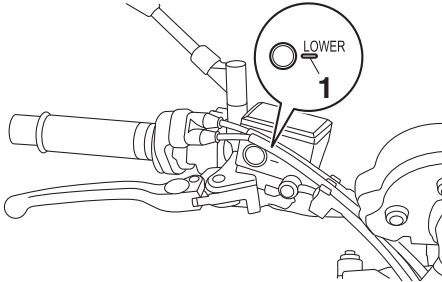

1. Minimum level mark

Rear brake

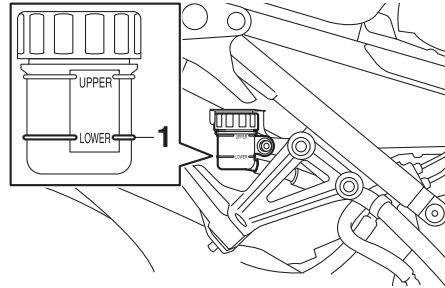

1. Minimum level mark

Specified brake fluid:
DOT 4

EWA16011

⚠ WARNING

Improper maintenance can result in loss of braking ability. Observe these precautions:

- **Insufficient brake fluid may allow air to enter the brake system, reducing braking performance.**
- **Clean the filler cap before removing. Use only DOT 4 brake fluid from a sealed container.**
- **Use only the specified brake fluid; otherwise, the rubber seals**

may deteriorate, causing leakage.

- **Refill with the same type of brake fluid. Adding a brake fluid other than DOT 4 may result in a harmful chemical reaction.**
- **Be careful that water or dust does not enter the brake fluid reservoir when refilling. Water will significantly lower the boiling point of the fluid and may result in vapor lock, and dirt may clog the ABS hydraulic unit valves.**

ECA17641

NOTICE

Brake fluid may damage painted surfaces or plastic parts. Always clean up spilled fluid immediately.

As the brake pads wear, it is normal for the brake fluid level to gradually go down. A low brake fluid level may indicate worn brake pads and/or brake system leakage; therefore, be sure to check the brake pads for wear and the brake system for leakage. If the brake fluid level goes down suddenly, have a Yamaha dealer check the cause before

Periodic maintenance and adjustment

further riding.

EAU22734

Changing the brake fluid

Have a Yamaha dealer change the brake fluid every 2 years. In addition, have the seals of the master cylinders and brake calipers, as well as the brake hoses replaced at the intervals listed below or sooner if they are damaged or leaking.

- Brake seals: every 2 years
- Brake hoses: every 4 years

EAU22762

Drive chain slack

The drive chain slack should be checked before each ride and adjusted if necessary.

EAU2277G

To check the drive chain slack

1. Place the motorcycle on the sides-tand.

TIP

When checking and adjusting the drive chain slack, there should be no weight on the motorcycle.

2. Shift the transmission into the neutral position.
3. Measure the drive chain slack as shown.

Periodic maintenance and adjustment

EAU57971

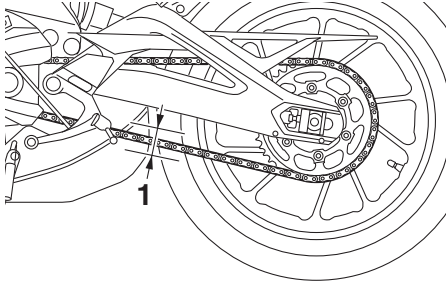

1. Drive chain slack

Drive chain slack:
5.0–15.0 mm (0.20–0.59 in)

4. If the drive chain slack is incorrect, adjust it as follows. **NOTICE: Improper drive chain slack will overload the engine as well as other vital parts of the motorcycle and can lead to chain slippage or breakage. If the drive chain slack is more than 25.0 mm (0.98 in), the chain can damage the frame, swingarm, and other parts. To prevent this from occurring, keep the drive chain slack within the specified limits.**^[ECA17791]

To adjust the drive chain slack
Consult a Yamaha dealer before adjusting the drive chain slack.

1. Loosen the axle nut and the locknut on each side of the swingarm.

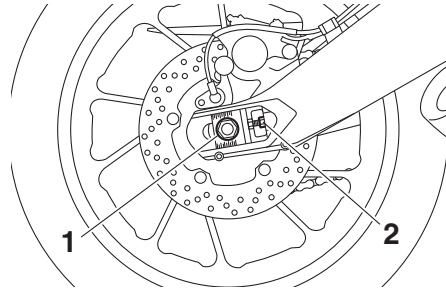

1. Axle nut
2. Locknut

2. To tighten the drive chain, turn the drive chain slack adjusting bolt on each side of the swingarm in direction (a). To loosen the drive chain, turn the adjusting bolt on each side of the swingarm in direction (b), and then push the rear wheel forward.

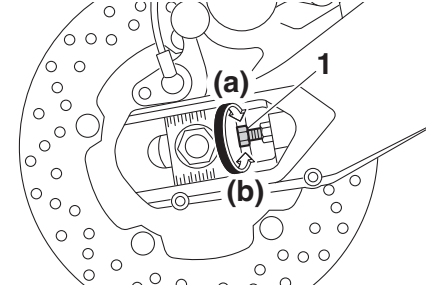

1. Drive chain slack adjusting bolt

TIP

Using the alignment marks and notch on each side of the swingarm, make sure that both drive chain pullers are in the same position for proper wheel alignment.

Periodic maintenance and adjustment

EAU23026

may contain substances that could damage the O-rings.^[ECA11112]

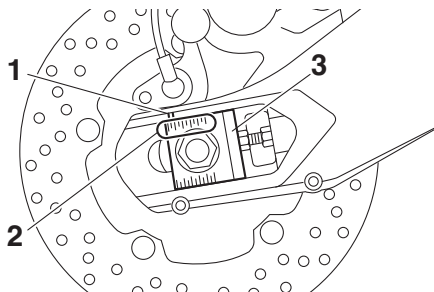

1. Notch
2. Alignment marks
3. Drive chain puller

3. Tighten the axle nut, then the locknuts to their specified torques.

Tightening torques:

Axle nut:

150 N·m (15 kgf·m, 111 lb·ft)

Locknut:

16 N·m (1.6 kgf·m, 12 lb·ft)

4. Make sure that the drive chain pullers are in the same position, the drive chain slack is correct, and the drive chain moves smoothly.

Cleaning and lubricating the drive chain

The drive chain must be cleaned and lubricated at the intervals specified in the periodic maintenance and lubrication chart, otherwise it will quickly wear out, especially when riding in dusty or wet areas. Service the drive chain as follows.

ECA10584

NOTICE

The drive chain must be lubricated after washing the motorcycle, riding in the rain or riding in wet areas.

1. Clean the drive chain with kerosene and a small soft brush.
NOTICE: To prevent damaging the O-rings, do not clean the drive chain with steam cleaners, high-pressure washers or inappropriate solvents.^[ECA11122]
2. Wipe the drive chain dry.
3. Thoroughly lubricate the drive chain with a special O-ring chain lubricant. **NOTICE: Do not use engine oil or any other lubricants for the drive chain, as they**

EAU23098

Checking and lubricating the cables

The operation of all control cables and the condition of the cables should be checked before each ride, and the cables and cable ends should be lubricated if necessary. If a cable is damaged or does not move smoothly, have a Yamaha dealer check or replace it. **WARNING! Damage to the outer housing of cables may result in internal rusting and cause interference with cable movement. Replace damaged cables as soon as possible to prevent unsafe conditions.**^[EWA10712]

Recommended lubricant:

Yamaha cable lubricant or other suitable cable lubricant

EAU23115

Checking and lubricating the throttle grip and cable

The operation of the throttle grip should be checked before each ride. In addition, the cable should be lubricated by a Yamaha dealer at the intervals specified in the periodic maintenance chart. The throttle cable is equipped with a rubber cover. Make sure that the cover is securely installed. Even though the cover is installed correctly, it does not completely protect the cable from water entry. Therefore, use care not to pour water directly onto the cover or cable when washing the vehicle. If the cable or cover becomes dirty, wipe clean with a moist cloth.

EAU44276

Checking and lubricating the brake and shift pedals

The operation of the brake and shift pedals should be checked before each ride, and the pedal pivots should be lubricated if necessary.

Brake pedal

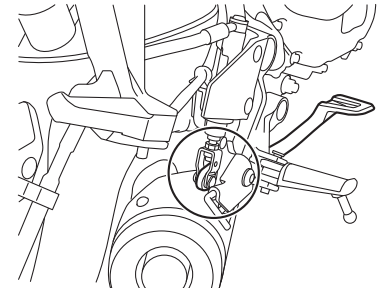

Periodic maintenance and adjustment

Shift pedal

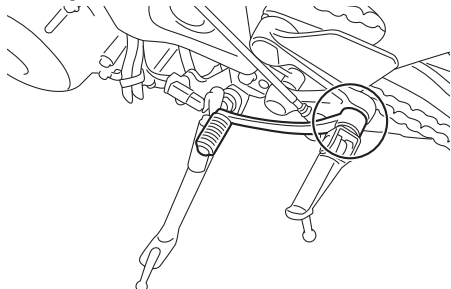

Recommended lubricant:
Lithium-soap-based grease

EAU23144

Checking and lubricating the brake and clutch levers

The operation of the brake and clutch levers should be checked before each ride, and the lever pivots should be lubricated if necessary.

Brake lever

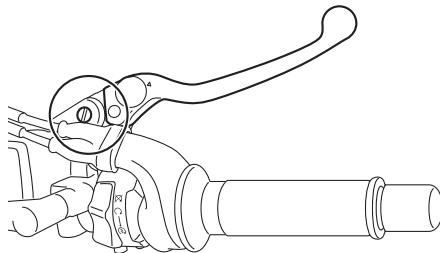

Clutch lever

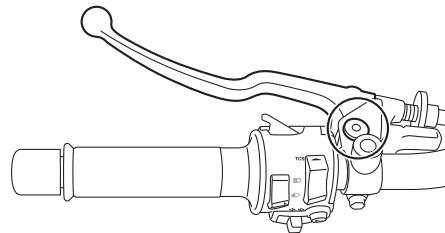

Recommended lubricants:

Brake lever:
Silicone grease
Clutch lever:
Lithium-soap-based grease

EAU23203

Checking and lubricating the sidestand

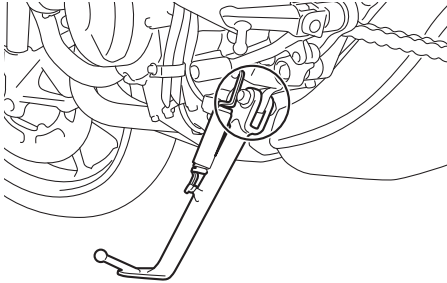

The operation of the sidestand should be checked before each ride, and the sidestand pivot and metal-to-metal contact surfaces should be lubricated if necessary.

EWA10732

WARNING

If the sidestand does not move up and down smoothly, have a Yamaha dealer check or repair it. Otherwise, the sidestand could contact the ground and distract the operator, resulting in a possible loss of control.

Recommended lubricant:
Lithium-soap-based grease

EAUM1653

Lubricating the swingarm pivots

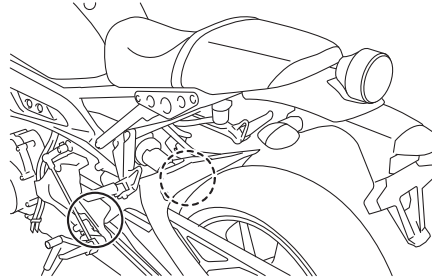

The swingarm pivots must be lubricated by a Yamaha dealer at the intervals specified in the periodic maintenance and lubrication chart.

Recommended lubricant:
Lithium-soap-based grease

EAU23273

Checking the front fork

The condition and operation of the front fork must be checked as follows at the intervals specified in the periodic maintenance and lubrication chart.

To check the condition

Check the inner tubes for scratches, damage and excessive oil leakage.

To check the operation

1. Place the vehicle on a level surface and hold it in an upright position. **WARNING! To avoid injury, securely support the vehicle so there is no danger of it falling over.**^[EWA10752]
2. While applying the front brake, push down hard on the handlebars several times to check if the front fork compresses and rebounds smoothly.

Periodic maintenance and adjustment

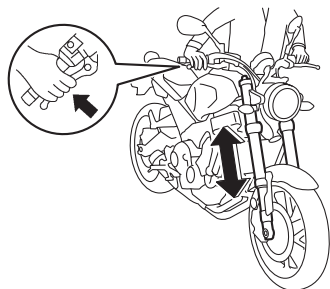

ECA10591

NOTICE

If any damage is found or the front fork does not operate smoothly, have a Yamaha dealer check or repair it.

Checking the steering

Worn or loose steering bearings may cause danger. Therefore, the operation of the steering must be checked as follows at the intervals specified in the periodic maintenance and lubrication chart.

1. Raise the front wheel off the ground. (See page 6-36.)
WARNING! To avoid injury, securely support the vehicle so there is no danger of it falling over.^[EWA10752]
2. Hold the lower ends of the front fork legs and try to move them forward and backward. If any free play can be felt, have a Yamaha dealer check or repair the steering.

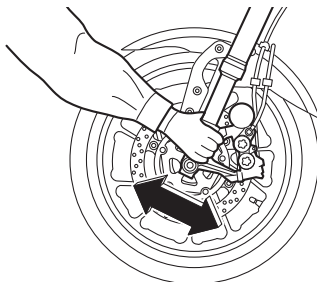

EAU23285

Checking the wheel bearings

EAU23292

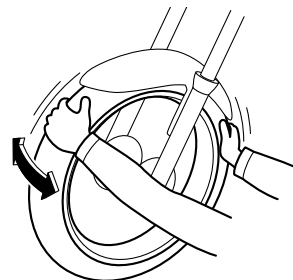

The front and rear wheel bearings must be checked at the intervals specified in the periodic maintenance and lubrication chart. If there is play in the wheel hub or if the wheel does not turn smoothly, have a Yamaha dealer check the wheel bearings.

Periodic maintenance and adjustment

Battery

EAU50292

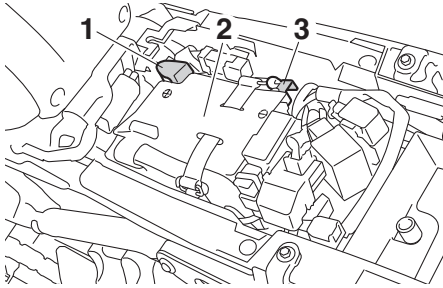

1. Positive battery lead (red)
2. Cover
3. Negative battery lead (black)

The battery is located under the seat. (See page 3-22.)

This model is equipped with a VRLA (Valve Regulated Lead Acid) battery. There is no need to check the electrolyte or to add distilled water. However, the battery lead connections need to be checked and, if necessary, tightened.

EWA10761

WARNING

- **Electrolyte is poisonous and dangerous since it contains sulfuric acid, which causes severe burns. Avoid any contact with**

skin, eyes or clothing and always shield your eyes when working near batteries. In case of contact, administer the following FIRST AID.

- **EXTERNAL:** Flush with plenty of water.
- **INTERNAL:** Drink large quantities of water or milk and immediately call a physician.
- **EYES:** Flush with water for 15 minutes and seek prompt medical attention.
- **Batteries produce explosive hydrogen gas. Therefore, keep sparks, flames, cigarettes, etc., away from the battery and provide sufficient ventilation when charging it in an enclosed space.**
- **KEEP THIS AND ALL BATTERIES OUT OF THE REACH OF CHILDREN.**

To charge the battery

Have a Yamaha dealer charge the battery as soon as possible if it seems to have discharged. Keep in mind that the

battery tends to discharge more quickly if the vehicle is equipped with optional electrical accessories.

ECA16522

NOTICE

To charge a VRLA (Valve Regulated Lead Acid) battery, a special (constant-voltage) battery charger is required. Using a conventional battery charger will damage the battery.

To store the battery

1. If the vehicle will not be used for more than one month, remove the battery, fully charge it, and then place it in a cool, dry place. **NOTICE:** When removing the battery, be sure to turn the main switch off, then disconnect the negative lead before disconnecting the positive lead.^[ECA16304]
2. If the battery will be stored for more than two months, check it at least once a month and fully charge it if necessary.
3. Fully charge the battery before installation. **NOTICE:** When installing the battery, be sure to turn

Periodic maintenance and adjustment

the main switch off, then connect the positive lead before connecting the negative lead.^[ECA16842]

4. After installation, make sure that the battery leads are properly connected to the battery terminals.

ECA16631

NOTICE

Always keep the battery charged. Storing a discharged battery can cause permanent battery damage.

6

Replacing the fuses

EAU73340

Fuse box 1 is located behind the right side panel.

To access fuse box 1, remove and install the right side panel and rubber cover as follows.

1. Remove the nuts and bolt.

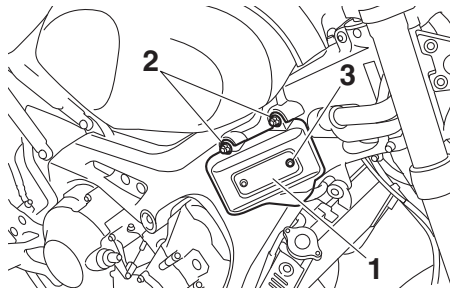

1. Right side panel
2. Nut
3. Bolt

2. Pull the right side panel and rubber cover off as shown.

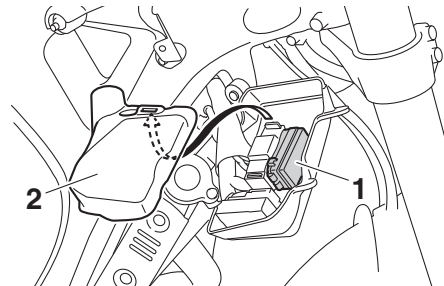
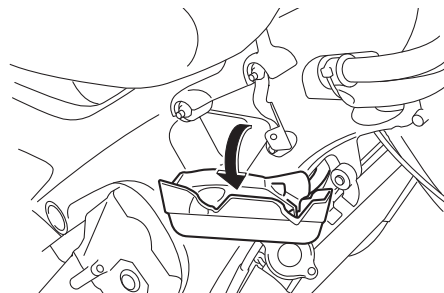

1. Fuse box 1
2. Rubber cover

Periodic maintenance and adjustment

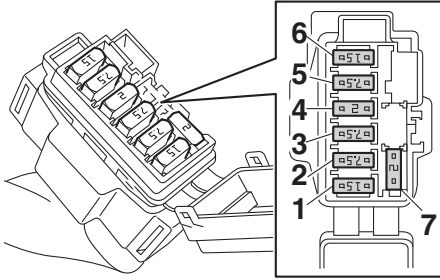

1. Ignition fuse
2. ABS control unit fuse
3. Parking lighting fuse
4. Auxiliary fuse 1
5. Signaling system fuse
6. Headlight fuse
7. Spare fuse

3. Place the panel and rubber cover in the original position.

4. Install the nuts and bolt.

The main fuse, the fuel injection system fuse, and fuse box 2 are located under the seat. (See page 3-22.)

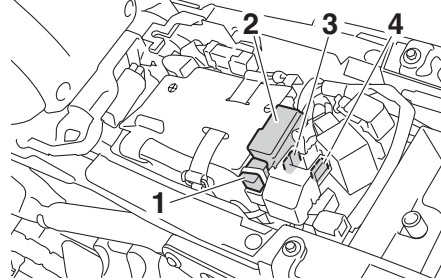

1. Main fuse
2. Fuse box 2
3. Fuel injection system fuse
4. Fuel injection system spare fuse

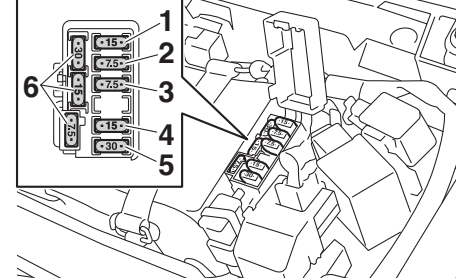

1. Radiator fan motor fuse
2. Backup fuse
3. Electronic throttle valve fuse
4. ABS solenoid fuse
5. ABS motor fuse
6. Spare fuse

TIP

To access the fuel injection system fuse, remove the starter relay cover by pulling it upward.

Periodic maintenance and adjustment

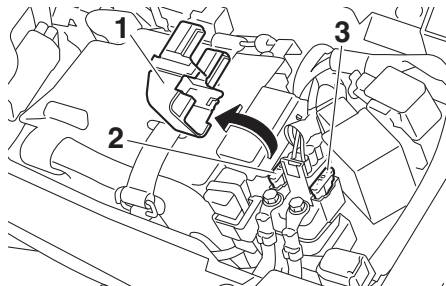

1. Starter relay cover
2. Fuel injection system fuse
3. Fuel injection system spare fuse

6

If a fuse is blown, replace it as follows.

1. Turn the key to “OFF” and turn off the electrical circuit in question.
2. Remove the blown fuse, and then install a new fuse of the specified amperage. **WARNING! Do not use a fuse of a higher amperage rating than recommended to avoid causing extensive damage to the electrical system and possibly a fire.**^[EWA15132]

Specified fuses:

- Main fuse:
50.0 A
- Headlight fuse:
15.0 A
- Signaling system fuse:
7.5 A
- Ignition fuse:
15.0 A
- Parking lighting fuse:
7.5 A
- Radiator fan motor fuse:
15.0 A
- ABS motor fuse:
30.0 A
- ABS solenoid fuse:
15.0 A
- Fuel injection system fuse:
10.0 A
- ABS control unit fuse:
7.5 A
- Backup fuse:
7.5 A
- Electronic throttle valve fuse:
7.5 A
- Auxiliary fuse 1:
2.0 A

check the electrical system.

3. Turn the key to “ON” and turn on the electrical circuit in question to check if the device operates.
4. If the fuse immediately blows again, have a Yamaha dealer

EAU34386

Replacing the headlight bulb

This model is equipped with a halogen bulb headlight. If the headlight bulb burns out, replace it as follows.

ECA10651

NOTICE

Take care not to damage the following parts:

- Headlight bulb

Do not touch the glass part of the headlight bulb to keep it free from oil, otherwise the transparency of the glass, the luminosity of the bulb, and the bulb life will be adversely affected. Thoroughly clean off any dirt and fingerprints on the headlight bulb using a cloth moistened with alcohol or thinner.

- Headlight lens

Do not affix any type of tinted film or stickers to the headlight lens.

Do not use a headlight bulb of a wattage higher than specified.

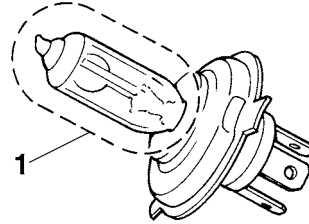

1. Do not touch the glass part of the bulb.

1. Remove the headlight unit by removing the bolts on each side.

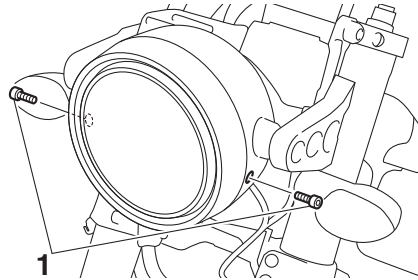

1. Bolt

2. Disconnect the headlight coupler, and then remove the headlight bulb cover.

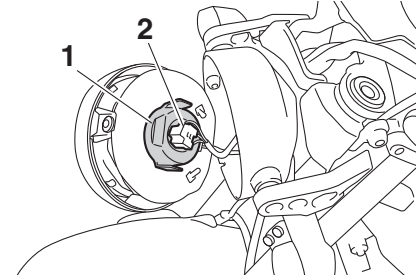

1. Headlight bulb cover
2. Headlight coupler

3. Unhook the headlight bulb holder, and then remove the burnt-out bulb.

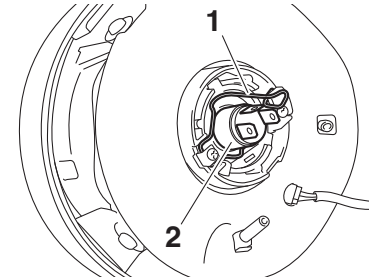

1. Headlight bulb holder
2. Headlight bulb

4. Place a new headlight bulb into po-

Periodic maintenance and adjustment

sition, and then secure it with the bulb holder.

5. Install the headlight bulb cover, and then connect the coupler.
6. Install the headlight unit by installing the bolts.
7. Have a Yamaha dealer adjust the headlight beam if necessary.

EAU45226

Replacing the auxiliary light bulb

If the auxiliary light bulb burns out, replace it as follows.

1. Remove the headlight unit. (See page 6-33.)
2. Remove the auxiliary light bulb socket (together with the bulb) by pulling it out.

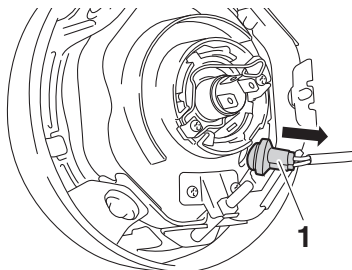

1. Auxiliary light bulb socket

3. Remove the burnt-out bulb by pulling it out.

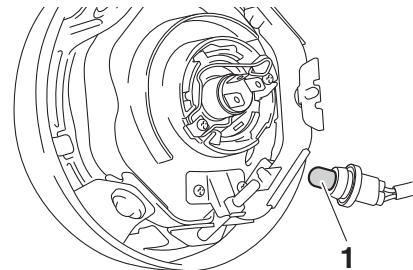

1. Auxiliary light bulb

4. Insert a new bulb into the socket.
5. Install the socket (together with the bulb) by pushing it in.
6. Install the headlight unit.

Brake/tail light

This model is equipped with an LED-type brake/tail light. If the brake/tail light does not come on, have a Yamaha dealer check it.

EAU70540

Replacing a turn signal light bulb

EAU24205

1. Remove the turn signal light lens by removing the screw.

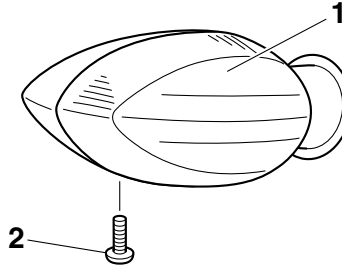

1. Turn signal light lens
2. Screw

2. Remove the burnt-out bulb by pushing it in and turning it counter-clockwise.

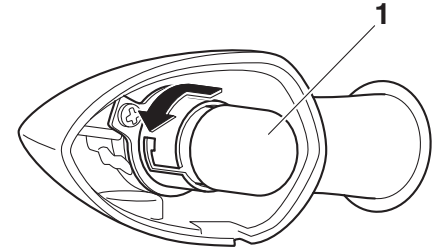

1. Turn signal light bulb
3. Insert a new bulb into the socket, push it in, and then turn it clockwise until it stops.
4. Install the lens by installing the screw. **NOTICE: Do not overtighten the screw, otherwise the lens may break.**^[ECA11192]

Periodic maintenance and adjustment

EAU24331

License plate light

If the license plate light does not come on, have a Yamaha dealer check the electrical circuit or replace the bulb.

EAU67131

Supporting the motorcycle

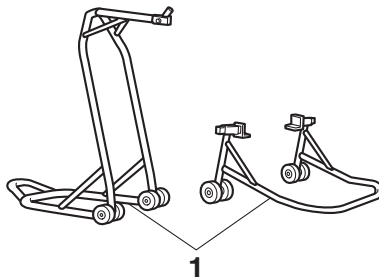

1. Maintenance stand (example)

Since this model is not equipped with a centerstand, use maintenance stands when removing the front or rear wheel or when performing other maintenance that requires the motorcycle to stand up right.

Check that the motorcycle is in a stable and level position before starting any maintenance.

EAU25872

Troubleshooting

Although Yamaha motorcycles receive a thorough inspection before shipment from the factory, trouble may occur during operation. Any problem in the fuel, compression, or ignition systems, for example, can cause poor starting and loss of power.

The following troubleshooting charts represent quick and easy procedures for checking these vital systems yourself. However, should your motorcycle require any repair, take it to a Yamaha dealer, whose skilled technicians have the necessary tools, experience, and know-how to service the motorcycle properly.

Use only genuine Yamaha replacement parts. Imitation parts may look like Yamaha parts, but they are often inferior, have a shorter service life and can lead to expensive repair bills.

EWA15142

WARNING

When checking the fuel system, do not smoke, and make sure there are no open flames or sparks in the area, including pilot lights from water

Periodic maintenance and adjustment

heaters or furnaces. Gasoline or gasoline vapors can ignite or explode, causing severe injury or property damage.

Periodic maintenance and adjustment

EAU42365

Troubleshooting charts

Starting problems or poor engine performance

1. Fuel

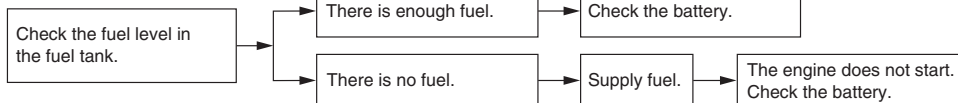

2. Battery

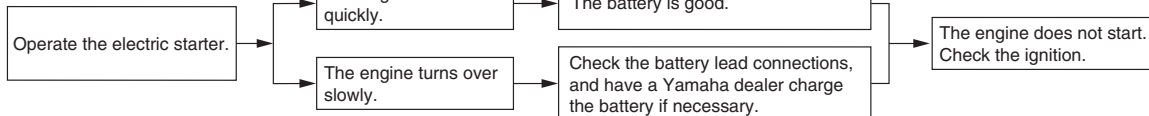

3. Ignition

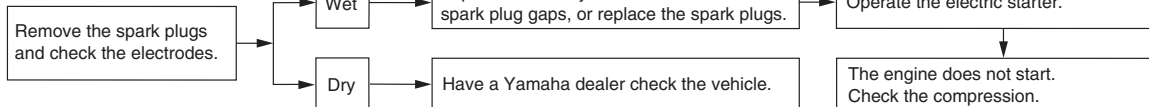

4. Compression

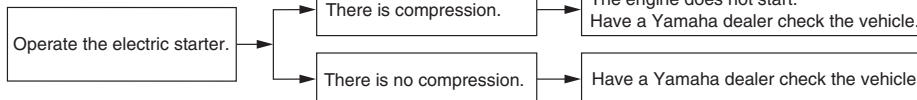

6

Periodic maintenance and adjustment

Engine overheating

EWA10401

WARNING

- Do not remove the radiator cap when the engine and radiator are hot. Scalding hot fluid and steam may be blown out under pressure, which could cause serious injury. Be sure to wait until the engine has cooled.
- After removing the radiator cap retaining bolt, place a thick rag, like a towel, over the radiator cap, and then slowly rotate the cap counterclockwise to the detent to allow any residual pressure to escape. When the hissing sound has stopped, press down on the cap while turning it counterclockwise, and then remove the cap.

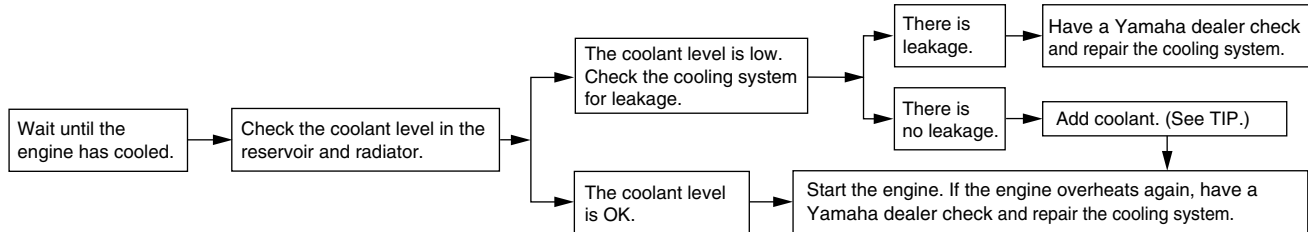

TIP

If coolant is not available, tap water can be temporarily used instead, provided that it is changed to the recommended coolant as soon as possible.

Motorcycle care and storage

EAU37834

Matte color caution

ECA15193

NOTICE

Some models are equipped with matte colored finished parts. Be sure to consult a Yamaha dealer for advice on what products to use before cleaning the vehicle. Using a brush, harsh chemical products or cleaning compounds when cleaning these parts will scratch or damage their surface. Wax also should not be applied to any matte colored finished parts.

7

EAU83443

Care

Frequent, thorough cleaning of the vehicle will not only enhance its appearance but also will improve its general performance and extend the useful life of many components. Washing, cleaning, and polishing will also give you a chance to inspect the condition of the vehicle more frequently. Be sure to wash the vehicle after riding in the rain or near the sea, because salt is corrosive to metals.

TIP

- The roads of heavy snowfall areas may be sprayed with salt as a de-icing method. This salt can stay on the roads well into spring, so be sure to wash the underside and chassis parts after riding in such areas.
 - Genuine Yamaha care and maintenance products are sold under the YAMALUBE brand in many markets worldwide.
 - See your Yamaha dealer for additional cleaning tips.
-

ECA26280

NOTICE

Improper cleaning can cause cosmetic and mechanical damage. Do not use:

- high-pressure washers or steam-jet cleaners. Excessive water pressure may cause water seepage and deterioration of wheel bearings, brakes, transmission seals and electrical devices. Avoid high-pressure detergent applications such as those available in coin-operated car washers.
- harsh chemicals, including strong acidic wheel cleaners, especially on spoke or magnesium wheels.
- harsh chemicals, abrasive cleaning compounds, or wax on matte-finished parts. Brushes can scratch and damage the matte-finish, use soft sponge or towel only.
- towels, sponges, or brushes contaminated with abrasive cleaning products or strong chemicals such as, solvents,

gasoline, rust removers, brake fluid, or antifreeze, etc.

Before washing

1. Park the vehicle out of direct sunlight and allow it to cool. This will help avoid water spots.
2. Make sure all caps, covers, electrical couplers and connectors are tightly installed.
3. Cover the muffler end with a plastic bag and a strong rubber band.
4. Pre-soak stubborn stains like insects or bird droppings with a wet towel for a few minutes.
5. Remove road grime and oil stains with a quality degreasing agent and a plastic-bristle brush or sponge. **NOTICE: Do not use degreasing agent on areas requiring lubrication such as seals, gaskets, and wheel axles. Follow product instructions.**^[ECA26290]

Washing

1. Rinse off any degreaser and spray down the vehicle with a garden hose. Use only enough pressure

to do the job. Avoid spraying water directly into the muffler, instrument panel, air inlet, or other inner areas such as underseat storage compartments.

2. Wash the vehicle with a quality automotive-type detergent mixed with cool water and a soft, clean towel or sponge. Use an old toothbrush or plastic-bristle brush for hard-to-reach places. **NOTICE: Use cold water if the vehicle has been exposed to salt. Warm water will increase salt's corrosive properties.**^[ECA26301]
3. For windshield-equipped vehicles: Clean the windshield with a soft towel or sponge dampened with water and a pH neutral detergent. If necessary, use a high-quality windshield cleaner or polish for motorcycles. **NOTICE: Never use any strong chemicals to clean the windshield. Additionally, some cleaning compounds for plastic may scratch the windshield, so be sure to test all cleaning products before general application.**^[ECA26310]

4. Rinse off thoroughly with clean water. Be sure to remove all detergent residues, as they can be harmful to plastic parts.

After washing

1. Dry the vehicle with a chamois or absorbent towel, preferably microfiber terrycloth.
2. For drive chain-equipped models: Dry and then lubricate the drive chain to prevent rust.
3. Use a chrome polish to shine chrome, aluminum, and stainless steel parts. Often the thermally induced discoloring of stainless steel exhaust systems can be removed through polishing.
4. Apply a corrosion protection spray on all metal parts including chrome or nickel-plated surfaces. **WARNING! Do not apply silicone or oil spray to seats, hand grips, rubber foot pegs or tire treads. Otherwise these parts will become slippery, which could cause loss of control. Thoroughly clean the surfaces of these parts before**

Motorcycle care and storage

operating the vehicle.^[EWA20650]

6. Treat rubber, vinyl, and unpainted plastic parts with a suitable care product.
7. Touch up minor paint damage caused by stones, etc.
8. Wax all painted surfaces using a non-abrasive wax or use a detail spray for motorcycles.
9. When finished cleaning, start the engine and let it idle for several minutes to help dry any remaining moisture.
10. If the headlight lens has fogged up, start the engine and turn on the headlight to help remove the moisture.
11. Let the vehicle dry completely before storing or covering it.

ECA26320

NOTICE

- Do not apply wax to rubber or unpainted plastic parts.
 - Do not use abrasive polishing compounds as they will wear away the paint.
 - Apply sprays and wax sparingly. Wipe off excess afterwards.
-

EWA20660

WARNING

Contaminants left on the brakes or tires can cause loss of control.

- Make sure there is no lubricant or wax on the brakes or tires.
 - If necessary, wash the tires with warm water and a mild detergent.
 - If necessary, clean the brake discs and pads with brake cleaner or acetone.
 - Before riding at higher speeds, test the vehicle's braking performance and cornering behavior.
-

EAU83472

Storage

Always store the vehicle in a cool, dry place. If necessary, protect it against dust with a porous cover. Be sure the engine and the exhaust system are cool before covering the vehicle. If the vehicle often sits for weeks at a time between uses, the use of a quality fuel stabilizer is recommended after each fill-up.

ECA21170

NOTICE

- Storing the vehicle in a poorly ventilated room or covering it with a tarp, while it is still wet, will allow water and humidity to seep in and cause rust.
 - To prevent corrosion, avoid damp cellars, stables (because of the presence of ammonia) and areas where strong chemicals are stored.
-

Long term storage

Before storing the vehicle long term (60 days or more):

1. Make all necessary repairs and

- perform any outstanding maintenance.
2. Follow all instructions in the Care section of this chapter.
 3. Fill up the fuel tank, adding fuel stabilizer according to product instructions. Run the engine for 5 minutes to distribute treated fuel through the fuel system.
 4. For vehicles equipped with a fuel cock: Turn the fuel cock lever to the off position.
 5. For vehicles with a carburetor: To prevent fuel deposits from building up, drain the fuel in the carburetor float chamber into a clean container. Retighten the drain bolt and pour the fuel back into the fuel tank.
 6. Use a quality engine fogging oil according to product instructions to protect internal engine components from corrosion. If engine fogging oil is not available, perform the following steps for each cylinder:
 - a. Remove the spark plug cap and spark plug.
 - b. Pour a teaspoonful of engine oil into the spark plug bore.
 - c. Install the spark plug cap onto the spark plug, and then place the spark plug on the cylinder head so that the electrodes are grounded. (This will limit sparking during the next step.)
 - d. Turn the engine over several times with the starter. (This will coat the cylinder wall with oil.)
WARNING! To prevent damage or injury from sparking, make sure to ground the spark plug electrodes while turning the engine over.^[EWA10952]
 - e. Remove the spark plug cap from the spark plug, and then install the spark plug and the spark plug cap.
 7. Lubricate all control cables, pivots, levers and pedals, as well as the sidestand and centerstand (if equipped).
 8. Check and correct the tire air pressure, and then lift the vehicle so that all wheels are off the ground. Otherwise, turn the wheels a little once a month in order to prevent the tires from becoming degraded in one spot.
 9. Cover the muffler outlet with a plastic bag to prevent moisture from entering it.
 10. Remove the battery and fully charge it, or attach a maintenance charger to keep the battery optimally charged. **NOTICE: Confirm that the battery and its charger are compatible. Do not charge a VRLA battery with a conventional charger.**^[ECA26330]

TIP

- If the battery will be removed, charge it once a month and store it in a temperate location between 0-30 °C (32-90 °F).
- See page 6-29 for more information on charging and storing the battery.

Specifications

Dimensions:

- Overall length:
2075 mm (81.7 in)
- Overall width:
815 mm (32.1 in)
- Overall height:
1140 mm (44.9 in)
- Seat height:
830 mm (32.7 in)
- Wheelbase:
1440 mm (56.7 in)
- Ground clearance:
135 mm (5.31 in)
- Minimum turning radius:
3.0 m (9.84 ft)

Weight:

- Curb weight:
195 kg (430 lb)

Engine:

- Combustion cycle:
4-stroke
- Cooling system:
Liquid cooled
- Valve train:
DOHC
- Cylinder arrangement:
Inline
- Number of cylinders:
3-cylinder
- Displacement:
847 cm³
- Bore × stroke:
78.0 × 59.1 mm (3.07 × 2.33 in)

- Starting system:
Electric starter

Engine oil:

- Recommended brand:



- SAE viscosity grades:
10W-40
- Recommended engine oil grade:
API service SG type or higher, JASO standard MA
- Engine oil quantity:
Oil change:
2.40 L (2.54 US qt, 2.11 Imp.qt)
- With oil filter removal:
2.70 L (2.85 US qt, 2.38 Imp.qt)

Coolant quantity:

- Coolant reservoir (up to the maximum level mark):
0.25 L (0.26 US qt, 0.22 Imp.qt)
- Radiator (including all routes):
1.93 L (2.04 US qt, 1.70 Imp.qt)

Fuel:

- Recommended fuel:
Premium unleaded gasoline (Gasohol [E10] acceptable)
- Fuel tank capacity:
14 L (3.7 US gal, 3.1 Imp.gal)
- Fuel reserve amount:
2.6 L (0.69 US gal, 0.57 Imp.gal)

Fuel injection:

- Throttle body:
ID mark:
B901 00

Drivetrain:

- Gear ratio:
1st:
2.667 (40/15)
- 2nd:
2.000 (38/19)
- 3rd:
1.619 (34/21)
- 4th:
1.381 (29/21)
- 5th:
1.190 (25/21)
- 6th:
1.037 (28/27)

Front tire:

- Type:
Tubeless
- Size:
120/70 ZR17M/C(58W)
- Manufacturer/model:
BRIDGESTONE/S20F M

Rear tire:

- Type:
Tubeless
- Size:
180/55 ZR17M/C (73W)
- Manufacturer/model:
BRIDGESTONE/S20R M

Loading:

Maximum load:

170 kg (375 lb)

* (Total weight of rider, passenger, cargo and accessories)

Front brake:

Type:

Hydraulic dual disc brake

Rear brake:

Type:

Hydraulic single disc brake

Front suspension:

Type:

Telescopic fork

Rear suspension:

Type:

Swingarm (link suspension)

Electrical system:

System voltage:

12 V

Battery:

Model:

YTZ10S

Voltage, capacity:

12 V, 8.6 Ah (10 HR)

Headlight:

Bulb type:

Halogen bulb

Bulb wattage:

Headlight:

H4, 60.0 W/55.0 W

Brake/tail light:

LED

Front turn signal light:

10.0 W

Rear turn signal light:

10.0 W

Auxiliary light:

5.0 W

License plate light:

5.0 W

Consumer information

EAU53562

Identification numbers

Record the vehicle identification number, engine serial number, and the model label information in the spaces provided below. These identification numbers are needed when registering the vehicle with the authorities in your area and when ordering spare parts from a Yamaha dealer.

VEHICLE IDENTIFICATION NUMBER:

ENGINE SERIAL NUMBER:

MODEL LABEL INFORMATION:

Vehicle identification number

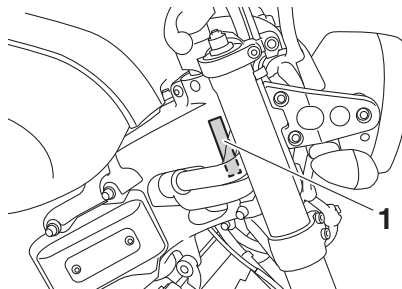

1. Vehicle identification number

The vehicle identification number is stamped into the steering head pipe. Record this number in the space provided.

TIP _____

The vehicle identification number is used to identify your motorcycle and may be used to register your motorcycle with the licensing authority in your area.

EAU26401

Engine serial number

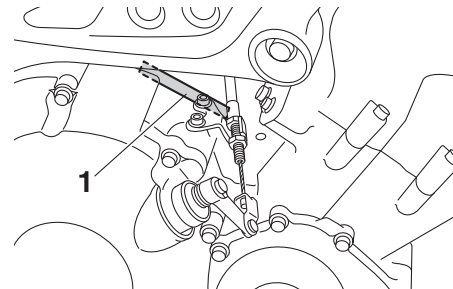

1. Engine serial number

The engine serial number is stamped into the crankcase.

EAU26442

Model label

EAU26481

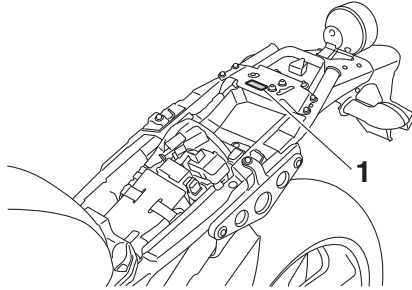

1. Model label

The model label is affixed to the frame under the seat. (See page 3-22.) Record the information on this label in the space provided. This information will be needed when ordering spare parts from a Yamaha dealer.

Diagnostic connector

EAU69910

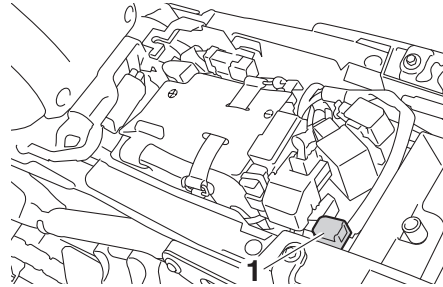

1. Diagnostic connector

The diagnostic connector is located as shown.

Vehicle data recording

EAU85300

This model's ECU stores certain vehicle data to assist in the diagnosis of malfunctions and for research, statistical analysis and development purposes.

Although the sensors and recorded data will vary by model, the main data points are:

- Vehicle status and engine performance data
- Fuel-injection and emission-related data

This data will be uploaded only when a special Yamaha diagnostic tool is attached to the vehicle, such as when maintenance checks or service procedures are performed.

Vehicle data uploaded will be handled appropriately according to the following Privacy Policy.

Privacy Policy

<https://www.yamaha-motor.eu/eu/privacy/privacy-policy.aspx>

Yamaha will not disclose this data to a third party except in the following cas-

Consumer information

es. In addition, Yamaha may provide vehicle data to a contractor in order to outsource services related to the handling of vehicle data. Even in this case, Yamaha will require the contractor to properly handle the vehicle data we provided and Yamaha will appropriately manage the data.

- With the consent of the vehicle owner
- Where obligated by law
- For use by Yamaha in litigation
- When the data is not related to an individual vehicle nor owner

- A**
ABS 3-16
ABS warning light 3-4
Air filter element 6-14
Auxiliary DC connector 3-26
Auxiliary light bulb, replacing 6-34
- B**
Battery 6-29
Brake and clutch levers, checking and lubricating 6-26
Brake and shift pedals, checking and lubricating 6-25
Brake fluid, changing 6-22
Brake fluid level, checking 6-21
Brake lever 3-15
Brake lever free play, checking 6-19
Brake light switches 6-20
Brake pedal 3-16
Brake/tail light 6-35
- C**
Cables, checking and lubricating 6-25
Canister 6-10
Care 7-1
Catalytic converter 3-21
Clutch lever 3-14
Clutch lever free play, adjusting 6-18
Coolant 6-13
Coolant temperature warning light 3-4
- D**
Data recording, vehicle 9-2
Diagnostic connector 9-2
Dimmer switch 3-13
D-mode (drive mode) 3-12
Drive chain, cleaning and lubricating 6-22
- Drive chain slack 6-22
- E**
Engine break-in 5-3
Engine idling speed, checking 6-15
Engine oil 6-10
Engine serial number 9-1
Engine trouble warning light 3-4
- F**
Front and rear brake pads, checking 6-20
Front fork, adjusting 3-23
Front fork, checking 6-27
Fuel 3-19
Fuel consumption, tips for reducing 5-3
Fuel tank breather hose and overflow hose 3-21
Fuel tank cap 3-18
Fuses, replacing 6-30
- H**
Handlebar switches 3-13
Hazard switch 3-14
Headlight bulb, replacing 6-33
High beam indicator light 3-4
Horn switch 3-13
- I**
Identification numbers 9-1
Ignition circuit cut-off system 3-27
Immobilizer system 3-1
Immobilizer system indicator light 3-5
Indicator lights and warning lights 3-3
- L**
License plate light 6-36
Luggage strap holders 3-26
- M**
Main switch/steering lock 3-2
- Maintenance and lubrication, periodic 6-5
Maintenance, emission control system 6-3
Matte color, caution 7-1
Model label 9-2
Multi-function meter unit 3-6
- N**
Neutral indicator light 3-4
- O**
Oil level warning light 3-4
- P**
Parking 5-4
Part locations 2-1
Pass switch 3-13
- S**
Safety information 1-1
Seat 3-22
Shifting 5-2
Shift pedal 3-15
Shock absorber assembly, adjusting 3-24
Sidestand 3-27
Sidestand, checking and lubricating 6-27
Spark plugs, checking 6-9
Specifications 8-1
Starting the engine 5-1
Steering, checking 6-28
Stop/Run/Start switch 3-14
Storage 7-3
Storage compartment 3-22
Supporting the motorcycle 6-36
Swingarm pivots, lubricating 6-27
- T**
Throttle grip and cable, checking and lubricating 6-25
Throttle grip free play, checking 6-15

Index

Tires	6-16
Tool kit	6-2
Traction control system	3-17
Traction control system indicator light.....	3-5
Traction control system switch	3-13
Troubleshooting	6-36
Troubleshooting charts	6-38
Turn signal indicator lights	3-3
Turn signal light bulb, replacing	6-35
Turn signal switch	3-13

V

Valve clearance	6-15
Vehicle identification number	9-1

W

Wheel bearings, checking.....	6-28
Wheels	6-18

Y

Yamalube.....	6-13
---------------	------

